

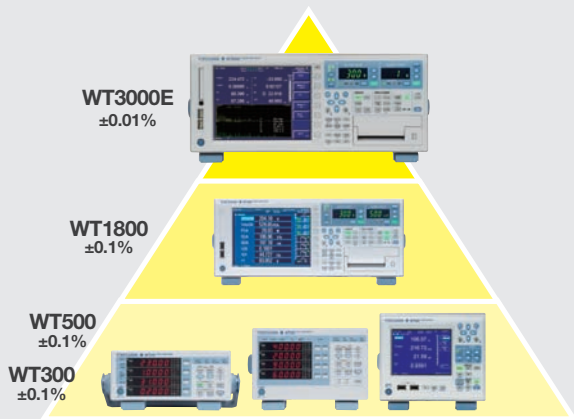

Highest accuracy & precision

WT3000E Precision Power Analyzer



Devices such as solar inverters are already working at overall efficiencies of 90 to 96%. To increase the efficiency, even by few decimal points, is a challenging and important goal for the manufacturers. As the world's most accurate power analyzer, the WT3000E provides the necessary levels of precision to truly confirm the smallest improvements in efficiency.

R&D engineers in industries and application areas such as motors & drives, semiconductors, lighting and domestic appliances now have an enhanced tool to measure power with higher levels of accuracy and stability.

The WT3000E is not only the benchmark for energy efficiency measurement but also a reference for calibrating power measuring instruments in standards laboratories.

The WT3000E has a robust architecture offering unbeatable performance following the footsteps of its predecessor. The focus on sustainable and renewable energy has raised the importance and need for manufacturers to comply to IEC standards during their product development.

The WT3000E provides the flexibility to mix 30A and 2A input current elements. This enables users to test the compliance of their products to the harmonics, flicker and standby power standards in a single instrument.

The WT3000E delivers

Accuracy – The WT3000E is the world's most trusted power analyzer thanks to its unmatched power accuracy.

Reliability – With proven high stability, the WT3000E not only provides the best power measurement accuracy but also the ability to repeat these results time and time again.

Expertise – The WT3000E represents 100 years of precision making and Innovation. With the widest variety of quality power measurement solutions, users can be confident that Yokogawa always provides the right solution for their needs.

100 Years of Precision Making

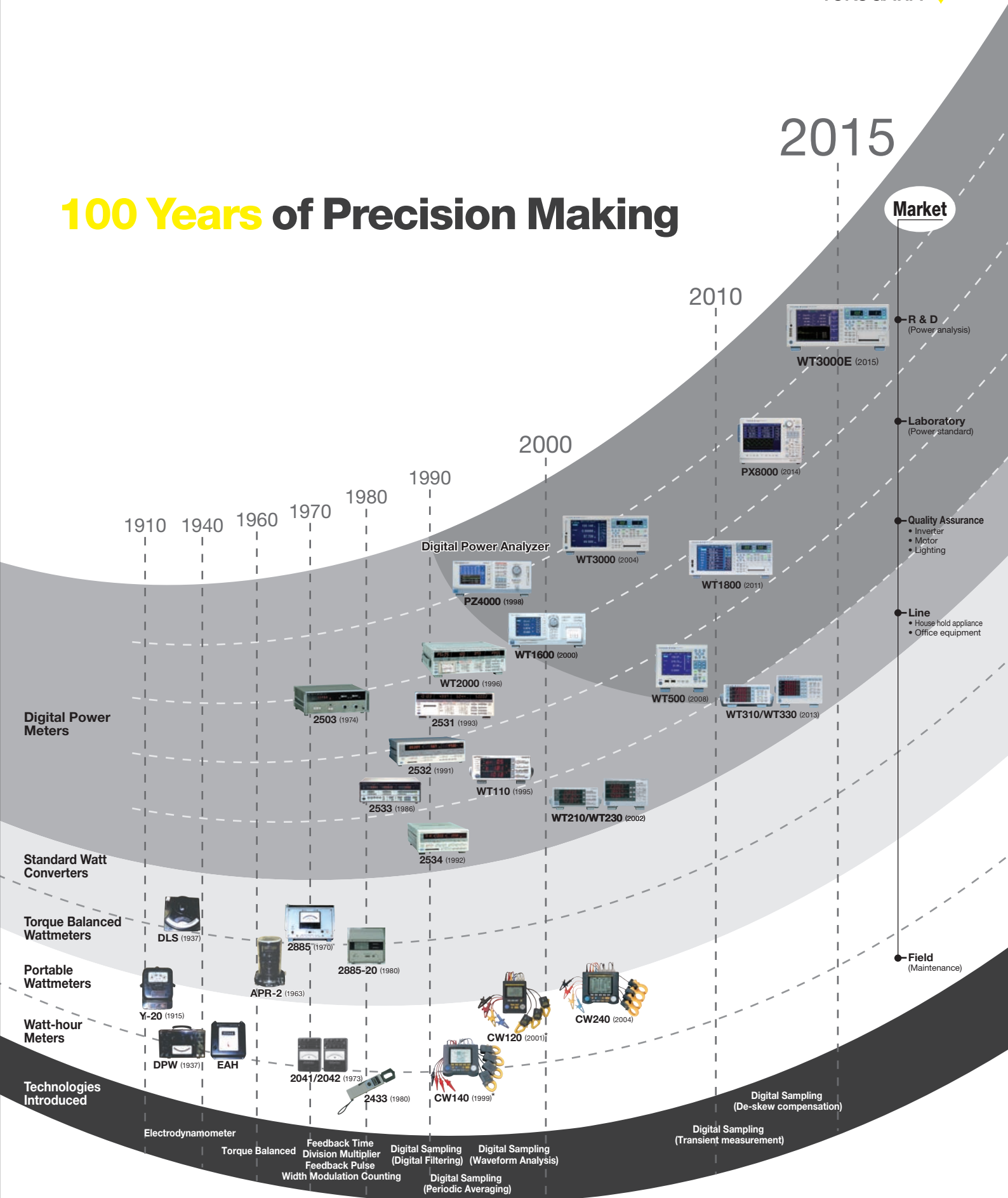

Features and benefits

World's highest accuracy

Inverters are already working at very high efficiencies. It is a challenge for manufacturers to further increase the efficiency even by few decimal points (0.1%).

To validate small improvements in efficiency, R&D teams need a new level of accuracy & precision in certified power measurement.

WT3000E is the world's most accurate power analyzer with the world's highest accuracy 0.01% (reading).

Along with high accuracy it provides a broad bandwidth from 0.1 Hz to 1 MHz with an improved accuracy from 0.1 Hz to 30 Hz.



Precision compensation functions

The function in the WT3000E compensates for the loss caused by the wiring of each element. The WT3000E provides the following three types of correction functions to measure power and efficiency.

- Wiring Compensation
- Efficiency Compensation
- Compensation for the Two-Wattmeter Method

These compensation functions enable the WT3000E to measure power accurately and precisely.

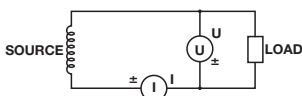

For U-I Wiring
Compensated instantaneous voltage:
 $u'(n) = u(n) - Ri \cdot i(n)$
The instantaneous current is $i(n)$.

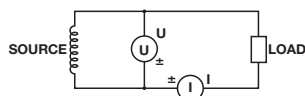

For I-U Wiring
Compensated instantaneous current:
 $i'(n) = i(n) - u(n)/R_u$
The instantaneous voltage is $u(n)$.

Three phase delta calculation

The delta calculation function in the WT3000E allows users to calculate individual phase voltages from the line voltages measured in a three-phase, three-wire (3V3A) system. The R-S line-to-line voltage can be calculated in systems measured from a three-phase, three-wire method (using two input elements). This function becomes very important when users want

Phase	Line Voltage (V)	Phase Voltage (V)	Angle (deg)
R-S	400.0	230.9	0.0
S-T	400.0	230.9	120.0
T-R	400.0	230.9	240.0

Delta calculation display

to determine the phase voltage in applications such as motor testing where there are no neutral lines.

*WT3000E should be equipped with at least two input elements with the same current input.

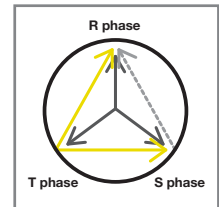
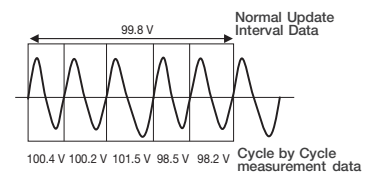

Image of Delta calculation

Cycle by cycle trend analysis

This analysis function enables users to list the measurement parameters such as voltage, current, and active power for each cycle. Input frequencies from 0.1 Hz to 1000 Hz



can be measured and up to 3000 data can be saved in .CSV format. Also by using Yokogawa's PC application software users can graphically display the data by cycle. Additionally by using Yokogawa's PC application software, users can graphically display the data per cycle.

Cycle No.	Source	Current (A)	Voltage (V)	Power (W)	Efficiency (%)
1	50.025	102.713	0.41913	43.214	45.157
2	50.025	102.690	0.41745	43.205	45.157
3	50.038	102.619	0.41872	43.122	45.054
4	50.025	102.687	0.41872	43.134	45.054
5	50.025	102.576	0.41822	43.129	45.054
6	50.038	102.683	0.41899	43.157	45.077
7	50.038	102.579	0.41804	43.162	45.054
8	50.025	102.662	0.41808	43.140	45.056
9	50.038	102.582	0.41804	43.138	45.054
10	50.038	102.705	0.41905	43.173	45.057
11	50.038	102.709	0.41885	43.155	45.074
12	50.038	102.708	0.41851	43.128	45.038
13	50.025	102.676	0.41872	43.179	45.043
14	50.038	102.585	0.41806	43.152	45.052
15	50.025	102.679	0.41802	43.154	45.074
16	50.038	102.575	0.41878	43.132	45.052
17	50.038	102.656	0.41884	43.112	45.052
18	50.025	102.643	0.41774	43.111	45.088
19	50.038	102.668	0.41806	43.153	45.073
20	50.038	102.653	0.41854	43.193	45.071

Measurement data display

Fast data update

The WT3000E has a maximum data update rate of 50 ms. The high speed allows users to capture fast changing transient signals with high precision. Once captured, analysis can be performed on the available data. The WT3000E switches between two different calculation algorithms depending on the data updating interval.

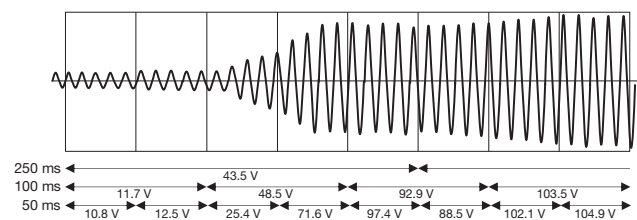

Advanced capabilities

5 Motor evaluation function (/MTR option)

Analog or pulse signals from a rotating sensor and torque meter can be input into the WT3000E using this option. This enables users to calculate the torque, revolution speed, mechanical power, synchronous speed, slip, motor efficiency, and total efficiency in a single unit. This is a powerful tool used in motor/inverter evaluation functions for total efficiency measurement.

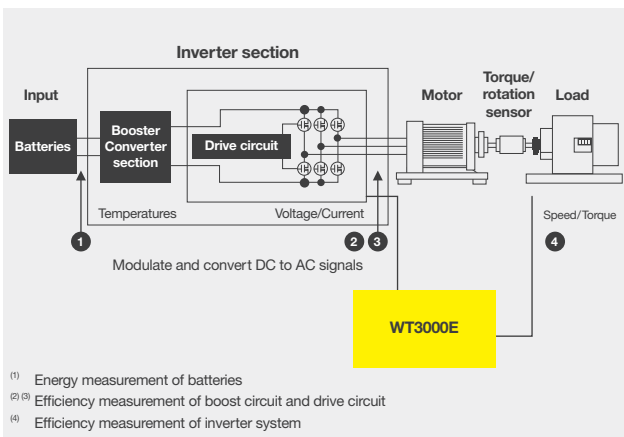

Advanced waveform analysis (/G6 option)

Harmonic measurement in normal measurement mode

The WT3000E enables users to measure harmonic data while operating in the normal measurement mode. This is invaluable when both power and harmonic data need to be measured simultaneously.

Wide bandwidth harmonic measurement

The function is useful for ascertaining the distortion factor and harmonic components in measurements of fundamental frequencies from 0.1 Hz to 2.6 kHz. It therefore enables wide bandwidth measurement of signals such as power supplies and the acceleration of motors.

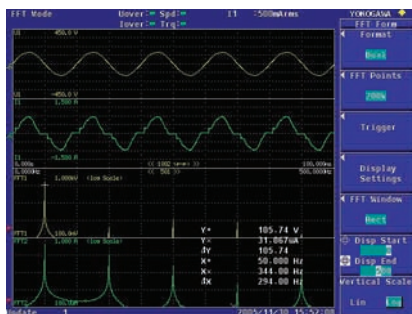

Input signal and FFT data

FFT (Fast Fourier Transform)

The WT3000E can analyze and display a waveform's individual frequency components. It can also check signal components other than the integer multiples of the fundamental wave.

Save raw waveform sample data

WT3000E can save sampling raw data of input waveforms, waveform computations, and FFT computations. The saved data can be accessed for any kind of computation by PC software.

Easy PC application software

This application software is a free tool which is used to read numeric, waveform, and harmonic data from the WT3000E Precision Power Analyzer through a communications interface such as GP-IB, Serial (RS-232, /C2), USB(/C12), or Ethernet (/C7).

Numeric data

The voltage, current, power and various other measured parameters can be simultaneously displayed for one to four elements and ΣA and ΣB calculations.

Harmonics measurement

The software can numerically or graphically display the results of measured harmonics up to the 100th order for parameters such as voltage, current, power and phase angle. (Requires the /G6 option in the WT3000E)

Waveform

Voltage and current waveforms can be monitored using the software and be used to confirm such things as phase differences between the voltage and current, and waveform distortion.

Viewing trends

The software can be used to capture and view various data measured using the WT3000E, on the PC in a graphical trend format. This feature enables the users to monitor power supply voltage fluctuations, changes in current consumption and other time-based variations.



PC display images

The WT3000E in detail

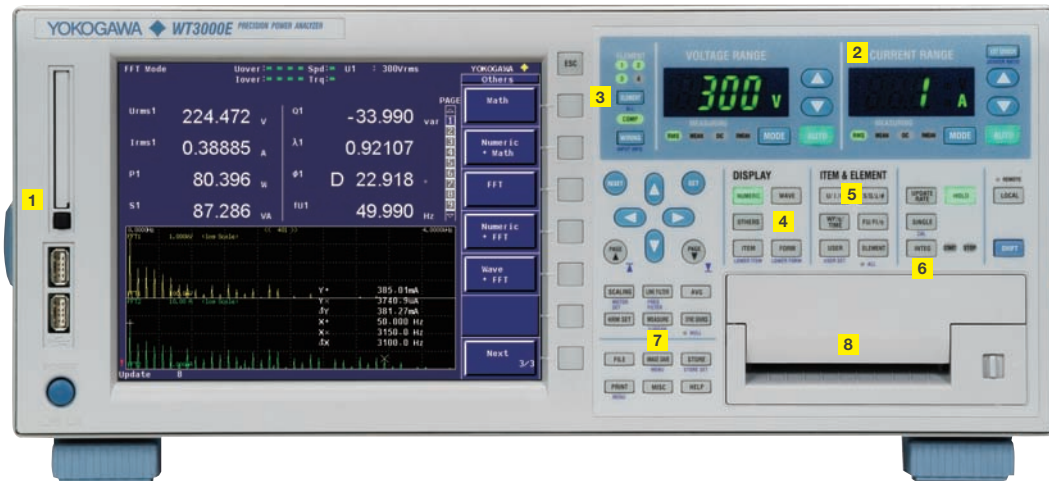

- | | | |
|------------------------------|-------------------------------------|---------------------------|
| 1 External media slot | 4 Display settings | 7 Data saving |
| 2 U/I range display | 5 Measurement item selection | 8 Built-in printer |
| 3 Element setting | 6 Integration settings | |



Standard features

- 1** Voltage input terminals
- 2** External current sensor input terminals
- 3** Current input terminals
- 4** GP-IB port
- 5** BNC connector for two-system synchronized measurement

Optional features

- 6** Serial (RS-232) port (option/C2) or USB port (PC) (option/C12)
- 7** Ethernet port (100BASE-TX/10BASE-T) (option/C7)
- 8** VGA port (option/V1)
- 9** D/A output (option/DA)
- 10** Torque and speed input terminals (Motor Evaluation Option)

Two types of input elements

7 Performance of WT3000E

Basic Power Accuracy: $\pm(0.01\% \text{ of reading} + 0.03\% \text{ of range})^{*1}$

Measurement Bandwidth: DC, 0.1 Hz to 1 MHz

Low Power Factor Error: Power factor influence when $\cos\phi=0$
 0.03% of S
 S is reading value of apparent power
 ϕ is phase angle between voltage and current

Current Range

- Direct Input: 0.5/1/2/5/10/20/30 A*2
 5/10/20/50/100/200/500 mA, 1/2 A*2
 (30 A and 2 A input element can be installed together)
- External Input: 50/100/200/500 mV, 1/2/5/10 V*2

Voltage Range: 15/30/60/100/150/300/600/1000 V*2

Data Update rate: 50 ms to 20 sec

Effective input range: 1% to 130%

*1 Please refer to "specifications" in detail

*2 Voltage range and current range are for crest factor 3

2 A input element



30 A input element



Both 2 A and 30 A input elements can be installed in a single unit. This enables engineers to use a single WT3000E for multiple applications such as standby power measurement and the evaluation of various operating modes of the device under test.

Example of basic characteristics showing the WT3000E's high precision and excellent stability

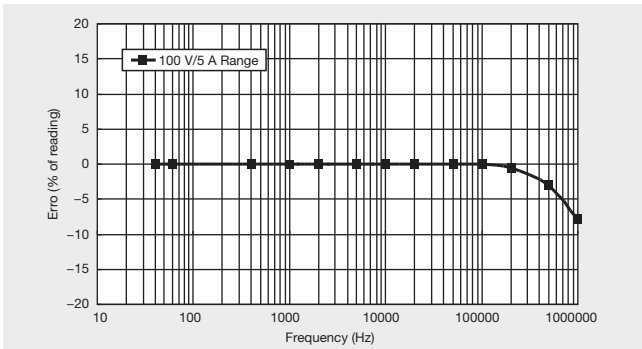

Example of Frequency versus Power accuracy characteristic

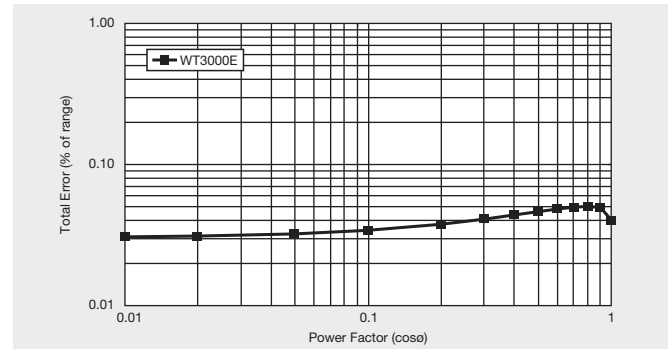

Total Power error with rated range Input for an arbitrary Power Factor (50/60 Hz, 30 A Input Element)

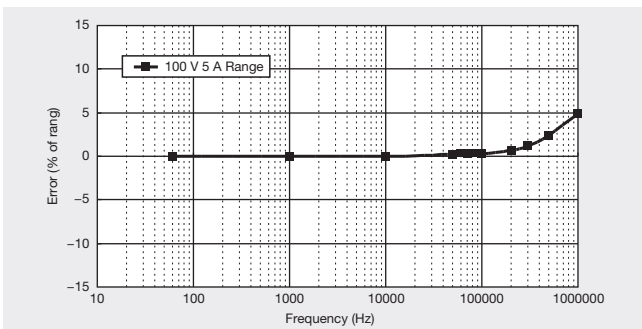

Example of Frequency characteristic under PF = 0 condition

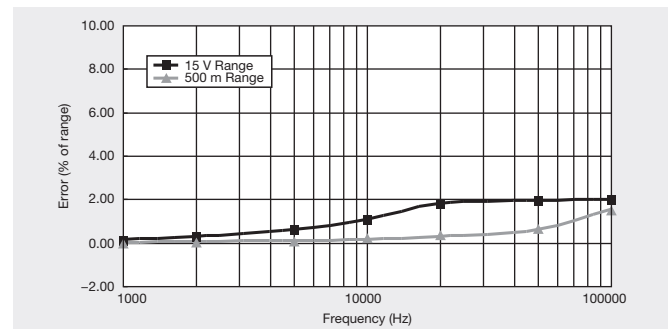

Effect of Common mode voltage on reading value

Applications

Accurate inverter/motor evaluation

Measuring efficiency with high precision:

Simultaneous input and output measurement

The WT3000E can perform measurements on up to 4 power input elements in a single unit. This enables users to simultaneously measure single-phase input/three-phase output, or three-phase input/three-phase output.

Accurate measurement of fundamental PWM voltage

Motor drive technology has become more complex in recent years; pure sine-wave PWM is less common, and cases in which the mean voltage differs greatly from the fundamental voltage waveform are more frequent. With the harmonic measurement option in the WT3000E, accurate measurements of commonly measured values such as active power and the fundamental or harmonic components can be taken simultaneously without changing the measurement mode. High frequency bandwidth is very important in order to measure PWM voltage and its active power correctly. With a broadband capability from DC to 1MHz, the WT3000E enables users to capture distorted waveforms accurately.

Phase voltage measurement without a neutral line (Delta calculation)

With the delta computation function, the device under test without a neutral line can be measured in a three-phase three-wire (3V3A) configuration, which enables each phase voltage to be calculated.

High frequency and harmonic measurements (/G6 option)

The fundamental frequencies of motors have become higher. The WT3000E allows harmonic measurements of signals with fundamental frequencies as high as 2.6 kHz.

Evaluation of torque speed characteristics (/MTR option, cycle by cycle measurement)

Torque speed can be evaluated based on the torque and revolution speed data measured with the motor evaluation function. Also, the WT3000E enables users to verify the cycle-by-cycle voltage, current, and power fluctuations that occur during the start of a motor.

Power conversion technologies similar to those used in Electric Vehicles (EVs) and power conditioners

High-precision, simultaneous measurements are required in measuring conversion efficiency of a converter while it converts three-phase input to a DC bus, and from an inverter's DC bus to three-phase output.

For measurements exceeding 30 A input, 2 A input elements can be used along with an AC/DC current sensor.

When measuring three-phase input/three-phase output with a three-phase four-wire system, the input and output can be measured simultaneously by synchronizing two WT3000E units.

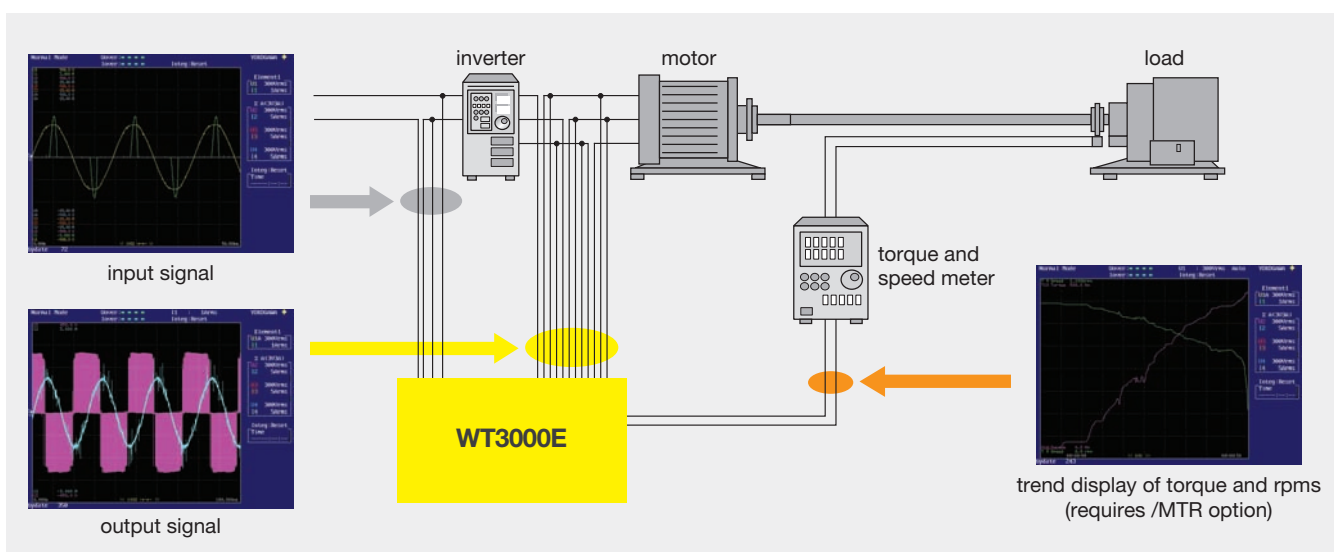

9 Harmonic and Voltage Fluctuation/ Flicker Measurement

Harmonic measurement (/G6 option)

The Harmonic Analysis Software (Model 761922) loads data measured by the WT3000E and performs harmonic analysis that complies with the latest IEC61000-3-2 & IEC61000-3-12 standards. The harmonic measurement software also performs harmonic measurement tests conforming to the latest IEC 61000-4-7 (window width is 10 cycles of 50 Hz and 12 cycles of 60 Hz) with WT3000E.

Communications: GP-IB, Ethernet (/C7)

Harmonic current measurement value list and bar graph

Enables PASS/FAIL evaluations of harmonic measurement results in line with standard class divisions (A, B, C, D). It displays lists of measurement values, as well as bar graphs that allows users to compare the measured value and standard limit value for each harmonic component.

Measurement mode

Three modes are available for harmonic measurement.

- **Harmonic observation:**
To view current, voltage, and phase angle for each order in a bar graph.
- **Waveform observation:**
To view measured signals to confirm the suitability of the range and other factors.
- **Harmonic measurement (standards testing):**
To conduct standards tests and to make the necessary judgments.

Efficiency is gained by performing tests after checking the waveform in Observation mode.

Flicker measurement (/FL option)

This function enables voltage fluctuation and flicker measurements in compliance with the latest IEC61600-3-3 & IEC61000-3-11 standards to be carried out.

*The WT3000E enables user to perform tests for flicker measurement. Also by using the 761922 harmonic/flicker measurement software, it is possible to display trend graphs, Cumulative probability (CPF) graphs, or reports of the dc, dmax, and Instantaneous flicker sensation (IFS) values in addition to the WT3000E evaluation results.

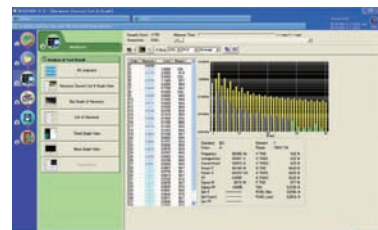

Harmonic bar graph display in harmonic observation mode

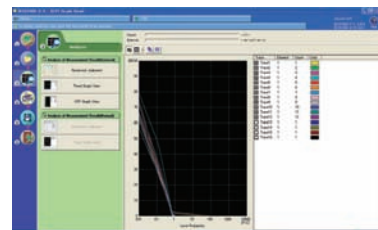

CPF graph display in Flicker observation mode

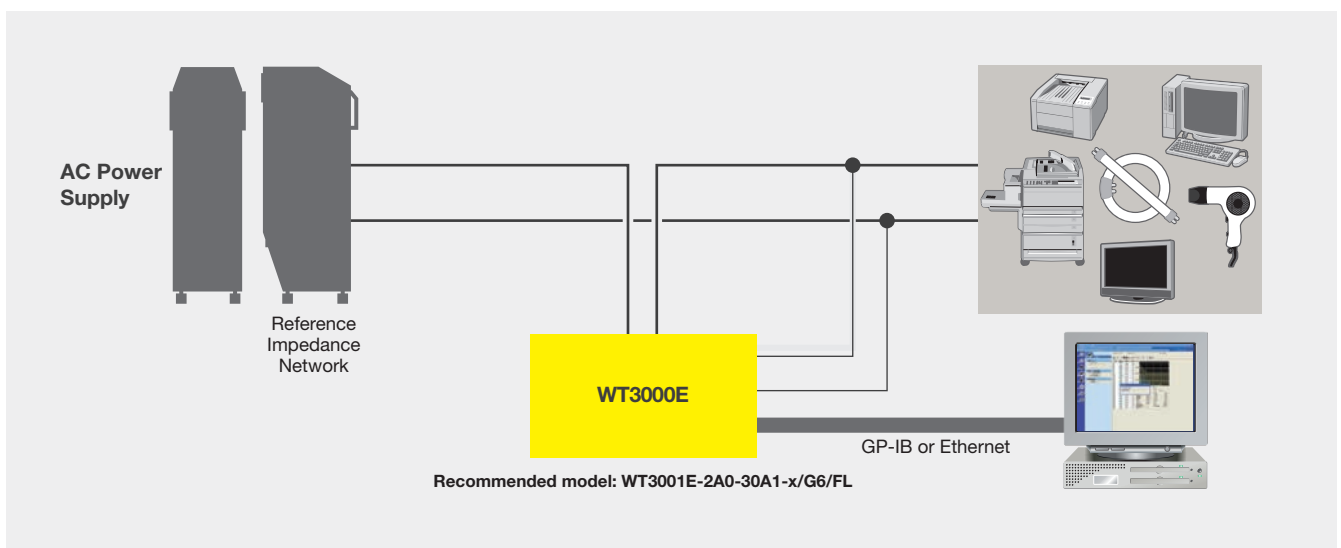

AC Magnetic material characteristics Testing

The WT3000E can be used to evaluate magnetic materials. Energy loss due to hysteresis characteristics or over currents occurring in iron cores is called core loss or iron loss. Measurements of iron loss using an Epstein device can be taken as-is because power calculated from secondary coil voltage and primary coil current does not include copper loss. The WT3000E can measure it accurately when a drive frequency of the power supply is much higher than commercial frequency. Also, if you input frequency, cross-sectional area, and other parameters, you can calculate the magnetic flux density B and AC magnetic field H using user-defined functions and display the results on screen of the WT3000E.

Core loss = Power value (W) × $\frac{N1}{N2}$

Measurement items are specified using the user-defined function as follows:

Magnetic Flux Density (B)

$$= \frac{\text{Voltage (Vmean)}}{4.44 \times \text{Current frequency} \times N2 \text{ (secondary number of turns)} \times \text{Cross section}}$$

Alternating Magnetic Field (H)

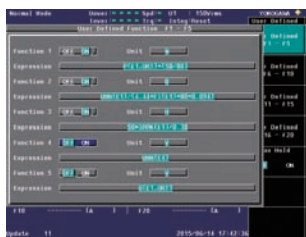
$$= \frac{N1 \text{ (primary number of turns)} \times \text{primary coil peak current (Apeak)}}{\text{Effective magnetic path length}}$$

User-defined function expression setting screen

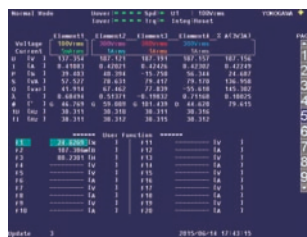

Up to twenty calculated results (from F1 to F20) can be displayed.

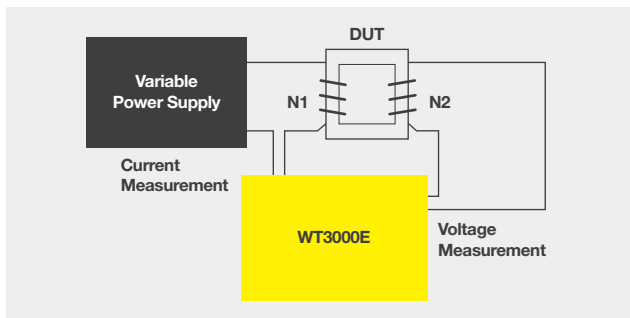

Power calibration

**Reference equipment for power calibration
basic power accuracy of 0.01% of reading**

The WT3000E can be used as a reference standard for periodic in-house calibration of general-purpose power measurement instruments, such as the WT310/WT330 series.

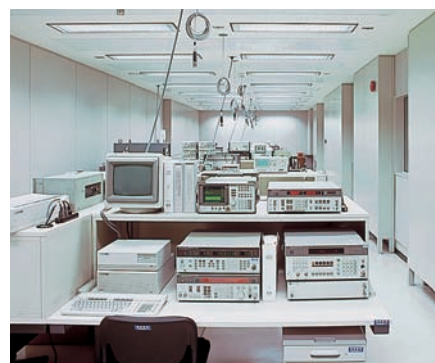
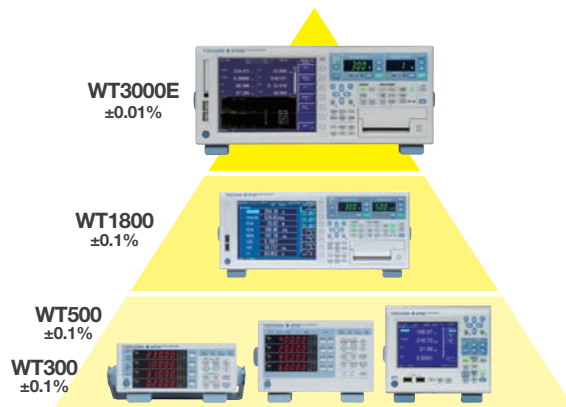

Temperature- and humidity-controlled calibration room

11 Semiconductor testing

Semiconductors are an integral part of any modern electronic circuit and are used in various applications from LED lighting to motor controls to build an energy efficient system. The WT3000E's high accuracy and stability along with the capability to perform harmonic and flicker measurements according to IEC standards place it at the heart of the semiconductor test system.

WT3000E advantage

Accurate & precise power measurement

In order to achieve higher efficiencies it is important to measure power at higher accuracies. The WT3000E provides basic power accuracy of $\pm 0.01\%$ (reading) in the guaranteed accuracy range from 1% to 130%.

Harmonic & flicker measurement

Semiconductors are used in various products such as high end power supplies, LED lighting, solar panels, motors & drives, Hybrid Electric Vehicle (HEV) / Uninterruptible Power System (UPS). It is important to perform harmonic and flicker analysis tests according to IEC standards. The WT3000E along with the 761922 software provides the option to perform either pre-compliance testing or 100% compliance to the latest IEC61000-3-2, IEC61000-3-3 & IEC61000-4-7, IEC61000-4-15 standards.

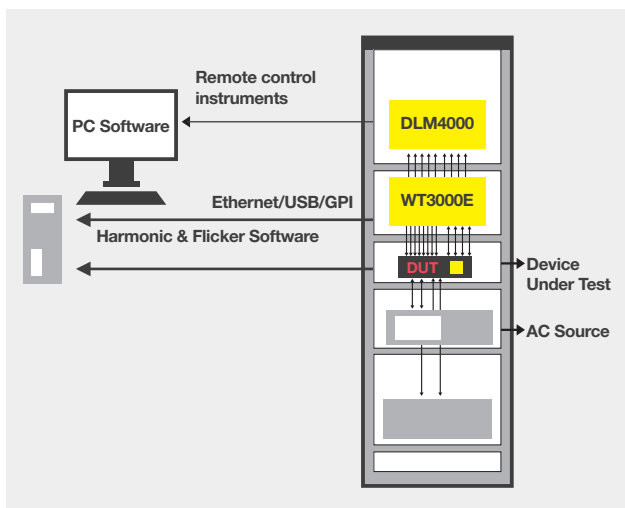

Lighting evaluation

Evaluation of lighting devices

Testing of high frequency lighting devices often involves measurement of voltage, current, and Total Harmonic Distortion (THD), a parameter that indicates the quality of power. This is because distortion in voltage and current waveforms is becoming more prevalent due to the increasing complexity of control systems.

The WT3000E can simultaneously measure voltage and current with THD, and allows for more accurate and rapid measurements of an instrument's characteristics and fluctuations.

Currently LEDs are rapidly replacing incandescent light bulbs and compact fluorescents (CFLs). The main reason is because LED lighting is more energy efficient. In case of LED lighting systems it is important to measure small DC currents and the dimmer control circuit needs high frequency measurement capability. Both 2 A and 30 A input elements can be installed in the same WT3000E and provides up to 1 MHz broadband performance. Thus users are able to fully evaluate their LED systems.

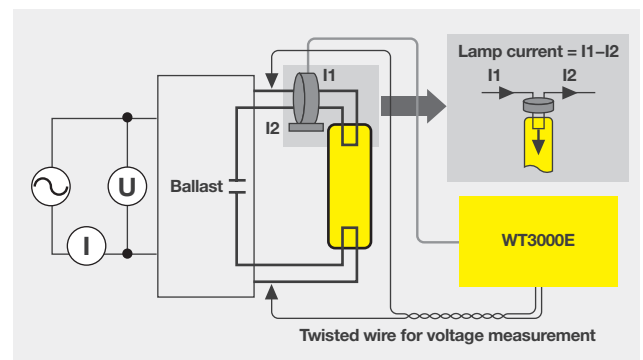

Example of fluorescent lamp wire connection

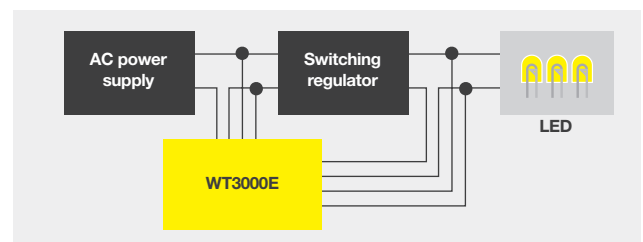

Specifications

WT3000E

Inputs	
Input terminal type	
Voltage	Plug-in terminal (safety terminal)
Current	Direct input: Large binding post External Current Sensor input: Insulated BNC connector
Input type	
Voltage	Floating input, resistive potential divider method
Current	Floating input, shunt input method
Measurement range (rated value)	
Voltage	15 V, 30 V, 60 V, 100 V, 150 V, 300 V, 600 V, 1000 V (for crest factor 3) 7.5 V, 15 V, 30 V, 50 V, 75 V, 150 V, 300 V, 500 V (for crest factor 6)
Current (2 A input element)	
Direct input	5 mA, 10 mA, 20 mA, 50 mA, 100 mA, 200 mA, 500 mA, 1 A, 2 A (for crest factor 3) 2.5 mA, 5 mA, 10 mA, 25 mA, 50 mA, 100 mA, 250 mA, 500 mA, 1 A (for crest factor 6)
External Current Sensor input	50 mV, 100 mV, 200 mV, 500 mV, 1 V, 2 V, 5 V, and 10 V (for crest factor 3) 25 mV, 50 mV, 100 mV, 250 mV, 500 mV, 1 V, 2.5 V, and 5 V (for crest factor 6)
Current (30 A input element)	
Direct input	500 mA, 1 A, 2 A, 5 A, 10 A, 20 A, and 30 A (for crest factor 3) 250 mA, 500 mA, 1 A, 2.5 A, 5 A, 10 A, and 15 A (for crest factor 6)
External Current Sensor input	50 mV, 100 mV, 200 mV, 500 mV, 1 V, 2 V, 5 V, and 10 V (for crest factor 3) 25 mV, 50 mV, 100 mV, 250 mV, 500 mV, 1 V, 2.5 V, and 5 V (for crest factor 6)
Input impedance	
Voltage	Input resistance: Approx. 10 MΩ, input capacitance: Approx. 5 pF
Current (2 A input element)	
Direct input	Approx. 500 mΩ + approx. 0.07 μH
External Current Sensor input	Input resistance: Approx. 1 MΩ, input capacitance: Approx. 40 pF
Current (30 A input element)	
Direct input	Approx. 5.5 mΩ + approx. 0.03 μH
External Current Sensor input	Input resistance: Approx. 1 MΩ, input capacitance: Approx. 40 pF
Instantaneous maximum allowable input (1 s or less)	
Voltage	Peak value of 2500 V or RMS value of 1500 V, whichever is less.
Current (2 A input element)	
Direct input	Peak value of 9 A or RMS value of 3 A, whichever is less.
External Current Sensor input	Peak value less than or equal to 10 times the measurement range.
Current (30 A input element)	
Direct input	Peak value of 150 A or RMS value of 50 A, whichever is less.
External Current Sensor input	Peak value less than or equal to 10 times the measurement range.
Continuous maximum allowable input	
Voltage	Peak value of 1600 V or RMS value of 1100 V, whichever is less. Or up to 1500 Vdc. This is a reference value.
Current (2 A input element)	
Direct input	Peak value of 6 A or RMS value of 2.2 A, whichever is less.
External Current Sensor input	Peak value less than or equal to 5 times the measurement range.
Current (30 A input element)	
Direct input	Peak value of 90 A or RMS value of 33 A, whichever is less.
External Current Sensor input	Peak value less than or equal to 5 times the measurement range.
Continuous maximum common mode voltage (50/60 Hz)	
Voltage input terminals	1000 Vrms
Current input terminals	1000 Vrms (Maximum allowable voltage that can be measured) 600 Vrms (Rated voltage of EN61010-2-030 standard)
External current sensor input connector: 600 Vrms	
Important Safety Note: Do not touch the inside of the BNC connector of the External Current Sensor input for safety reasons.	
Rated voltage to ground	
Voltage input terminals	1000 V
Current input terminals	1000 V (Maximum allowable voltage that can be measured) 600 V (Rated voltage of EN61010-2-030 standard)
External current sensor input connector: 600 V	
Important Safety Note: Do not touch the inside of the BNC connector of the External Current Sensor input for safety reasons.	
Influence from common mode voltage	
Apply 1000 Vrms with the voltage input terminals shorted and the current input terminals open.	
• 50/60 Hz: ±0.01% of range or less	
• Reference value up to 200 kHz Voltage: ±3/range × f% of range or less. However, 3% or less. Current direct input and external current sensor input: ±(max. range/range) × 0.001 × f% of range or less. However, 0.01% or more. The units of f are kHz. The max. range within equations is 30 A or 2 A or 10 V.	
Line filter	Select OFF, 500 Hz, 5.5 kHz, or 50 kHz.
Frequency filter	Select OFF, or ON

A/D converter	Simultaneous voltage and current conversion and 16-bit resolution. Conversion speed (sampling rate): Approximately 5 μs. See harmonic measurement items for harmonic display.
Range switching	Can be set for each input element.
Auto range functions	
Increasing range value	<ul style="list-style-type: none"> When the measured values of U and I exceed 110% of the range rating When the peak value exceeds approximately 330% of the range rating (or approximately 660% for crest factor 6)
Decreasing range value	<ul style="list-style-type: none"> When the measured values of U and I fall to 30% or less of the range rating, and Upk and Ipk are 300% or less of the lower range value (or 600% for crest factor 6)

Display	
Display	8.4-inch color TFT LCD monitor
Total number of pixels*	640 (horiz.) × 480 (vert.) dots *Up to 0.02% of the pixels on the LCD may be defective.
Waveform display resolution	501 (horiz.) × 432 (vert.) dots

Display update	
Same as the data update rate. Exceptions are listed below.	
<ul style="list-style-type: none"> The display update interval of numeric display (4, 8, and 16 items) is 250 ms when the data update rate is 50 ms or 100 ms. The display update interval of numeric display (ALL, Single List, and Dual List) is 500 ms when the data update rate is 50 ms to 250 ms. The display update rate of the trend display, bar graph display, and vector display is 1 s when the data update rate is 50 ms to 500 ms. The display update interval of the waveform display is approximately 1 s when the data update rate is 50 ms to 1 s. However, it may be longer depending on the trigger setting. 	

Calculation Function				
	Single-phase, 3 wire	3 phase, 3 wire	3 phase, 3 wire (3 voltage 3 current)	3 phase, 4 wire
U_{Σ} [V]	$(U1+U2)/2$		$(U1+U2+U3)/3$	
I_{Σ} [A]	$(I1+I2)/2$		$(I1+I2+I3)/3$	
P_{Σ} [W]	P1+P2		P1+P2+P3	
S_{Σ} [VA]	TYPE1	S1+S2	$\frac{\sqrt{3}}{2}(S1+S2)$	$\frac{\sqrt{3}}{3}(S1+S2+S3)$
	TYPE2			S1+S2+S3
	TYPE3	$\sqrt{P_{\Sigma}^2+Q_{\Sigma}^2}$		
Q_{Σ} [var]	TYPE1	Q1+Q2		Q1+Q2+Q3
	TYPE2	$\sqrt{S_{\Sigma}^2-P_{\Sigma}^2}$		
	TYPE3	Q1+Q2		Q1+Q2+Q3
Pc_{Σ} [W]	Pc1+Pc2		Pc1+Pc2+Pc3	
WP_{Σ} [Wh]	WP1+WP2		WP1+WP2+WP3	
$WP+\Sigma$ [Wh]	WP+1+WP+2		WP+1+WP+2+WP+3	
$WP-\Sigma$ [Wh]	WP-1+WP-2		WP-1+WP-2+WP-3	
q_{Σ} [Ah]	q1+q2		q1+q2+q3	
$q+\Sigma$ [Ah]	q+1+q+2		q+1+q+2+q+3	
$q-\Sigma$ [Ah]	q-1+q-2		q-1+q-2+q-3	
WS_{Σ} [VAh]	$\frac{1}{N} \sum_{n=1}^N S_{\Sigma}(n) \times \text{Time}$ S _Σ (n) is the n th apparent power Σ function, and N is the number of data updates.			
WQ_{Σ} [varh]	$\frac{1}{N} \sum_{n=1}^N Q_{\Sigma}(n) \times \text{Time}$ Q _Σ (n) is the n th reactive power Σ function, and N is the number of data updates.			
λ_{Σ}	$\frac{P_{\Sigma}}{S_{\Sigma}}$			
ϕ_{Σ} [°]	$\cos^{-1}\left(\frac{P_{\Sigma}}{S_{\Sigma}}\right)$			

Note 1) The instrument's apparent power (S), reactive power (Q), power factor (λ), and phase angle (φ) are calculated using measured values of voltage, current, and active power.
(However, reactive power is calculated directly from sampled data when TYPE3 is selected.) Therefore, when distorted waveforms are input, these values may be different from those of other measuring instruments based on different measuring principals.

Note 2) The value of Q in the Q_Σ calculation is calculated with a preceding minus sign (-) when the current input leads the voltage input, and a plus sign when it lags the voltage input, so the value of Q_Σ may be negative.

η [%]	Set a efficiency calculation up to 4
User-defined functions F1 to F20	Create equations combining measurement function symbols, and calculate up to twenty numerical data.

Waveform Display (WAVE display)	
Waveform display items	Voltage and current from elements 1 through 4 Motor Evaluation option: torque and waveform of revolution speed

Accuracy

[Conditions] *These conditions are all accuracy condition in this section.
 Temperature: 23±5°C, Humidity: 30 to 75%RH, Input waveform: Sine wave, Common mode voltage: 0 V, Crest factor: 3, Line filter: OFF, λ (power factor): 1, After warm-up.
 After zero level, compensation or range value change while wired. f is frequency (kHz), 6-month

30 A input element, 2 A input element (50 mA to 2 A range) External Current Sensor Input, Voltage input

	Voltage/current	Power
DC	0.05% of reading + 0.05% of range (U, 30 A, Sensor) 0.05% of reading + 0.05% of range + 2 μA (2 A)	0.05% of reading + 0.1% of range 0.05% of reading + 0.1% of range + 2 μA × U reading (2 A)
0.1 Hz ≤ f < 30 Hz	0.03% of reading + 0.05% of range	0.08% of reading + 0.1% of range
30 Hz ≤ f < 45 Hz	0.03% of reading + 0.05% of range	0.05% of reading + 0.05% of range
45 Hz ≤ f ≤ 66 Hz	0.01% of reading + 0.03% of range	0.01% of reading + 0.03% of range
66 Hz < f ≤ 1 kHz	0.03% of reading + 0.05% of range	0.05% of reading + 0.05% of range
1 kHz < f ≤ 10 kHz	0.1% of reading + 0.05% of range	0.15% of reading + 0.1% of range
10 kHz < f ≤ 50 kHz	0.3% of reading + 0.1% of range	0.3% of reading + 0.2% of range
50 kHz < f ≤ 100 kHz	0.012 × f% of reading + 0.2% of range	0.014 × f% of reading + 0.3% of range
100 kHz < f ≤ 500kHz	0.009 × f% of reading + 0.5% of range	0.012 × f% of reading + 1% of range
500 kHz < f ≤ 1 MHz	(0.022 × f - 7)% of reading + 1% of range	(0.048 × f - 19)% of reading + 2% of range

U: Voltage, sensor: External Current Sensor input, 2 A: 500 mA, 1 A, 2 A range of 2 A direct current input, 30 A: 30 A direct current input

2 A input element (5 mA, 10 mA, and 20 mA range)

	Current	Power
DC	0.05% of reading + 0.05% of range + 2 μA (direct)	0.05% of reading + 0.1% of range + 2 μA × V reading (direct)
0.1 Hz ≤ f < 30 Hz	0.03% of reading + 0.05% of range	0.08% of reading + 0.1% of range
30 Hz ≤ f < 45 Hz	0.03% of reading + 0.05% of range	0.05% of reading + 0.05% of range
45 Hz ≤ f ≤ 66 Hz	0.03% of reading + 0.05% of range	0.05% of reading + 0.05% of range
66 Hz < f ≤ 1 kHz	0.03% of reading + 0.05% of range	0.05% of reading + 0.05% of range
1 kHz < f ≤ 10 kHz	0.1% of reading + 0.05% of range	0.15% of reading + 0.1% of range
10 kHz < f ≤ 50 kHz	0.3% of reading + 0.1% of range	0.3% of reading + 0.2% of range
50 kHz < f ≤ 100 kHz	0.012 × f% of reading + 0.2% of range	0.014 × f% of reading + 0.3% of range
100 kHz < f ≤ 500 kHz	0.009 × f% of reading + 0.5% of range	0.012 × f% of reading + 1% of range
500 kHz < f ≤ 1 MHz	(0.022 × f - 7)% of reading + 1% of range	(0.048 × f - 19)% of reading + 2% of range

U: Voltage, sensor: External Current Sensor input, direct: direct current input

*The units of f in the reading error equation are kHz.

- When the External Current Sensor input range is 50 mV, add 0.01% of reading + 0.01% of range to the power accuracy at 45 Hz ≤ f ≤ 66 Hz.

30 A input element/2 A input element

- Accuracy of waveform display data, Upk and lpk Add 3% of range to the accuracy above. However, add 3% of range + 5 mV for external current sensor input (reference value). Effective input range is within ±300% (within ±600% for crest factor 6)
- Influenced by changes in temperature after zero level correction or range value changes. Add 50 ppm of range/°C to the voltage DC accuracy, 0.2 mA/°C to the 30 A input current DC accuracy, 3 μA/°C to the 2 A current accuracy, 0.02 mV/°C to the external current DC accuracy, and influence of voltage times influence of current to the power DC accuracy.

30 A input element

- For self-generated heat caused by current input on an DC input signal, add 0.00002 × I² of reading + 3 × I² μA to the current accuracy.
- For self-generated heat caused by current input on an AC input signal, add 0.00002 × I² of reading.

I is the current reading (A). The influence from self-generated heat continues until the temperature of the shunt resistor inside the WT3000E lowers even if the current input changes to a small value.

2 A input element

- For self-generated heat caused by current input on an DC input signal, add 0.004 × I² of reading + 6 × I² μA to the current accuracy.
- For self-generated heat caused by current input on an AC input signal, add 0.004 × I² of reading.

I is the current reading (A). The influence from self-generated heat continues until the temperature of the shunt resistor inside the WT3000E lowers even if the current input changes to a small value.

- Additions to accuracy according to the data update rate Add 0.05% of reading when it is 100 ms, and 0.1% of reading when 50 ms.
- Range of guaranteed accuracy by frequency, voltage, and current All accuracies between 0.1 Hz and 10 Hz are reference values.
 If the voltage exceeds 750 V at 30 kHz to 100 kHz, or exceeds {2.2 × 10⁻⁷ / f(kHz)} V at 100 kHz to 1 MHz, the voltage and power values are reference values.
 If the current exceeds 20 A at DC, 10 Hz to 45Hz, or 400 Hz to 200 kHz; or if it exceeds 10 A at 200 kHz to 500 kHz; or exceeds 5 A at 500 kHz to 1 MHz, the current and power accuracies are reference values.
- Accuracy for crest factor 6: Range accuracy of crest factor 3 for two times range.

Total power accuracy with respect to the range for an arbitrary power factor λ (exclude λ = 1)

Power When λ = 0 (500 mA to 30 A range)
 Apparent power reading × 0.03% in the 45 to 66 Hz range
 All other frequencies are as follows (however, these are only reference values):
 Apparent power reading × (0.03 + 0.05 × f (kHz))%
 When λ = 0 (5 mA to 200 mA range)
 Apparent power reading × 0.1% in the 45 to 66 Hz range
 All other frequencies are as follows (however, these are only reference values):
 Apparent power reading × (0.1 + 0.05 × f (kHz))%
 0 < λ < 1 (45 Hz to 66 Hz)
 (Power reading) × [(power reading error %) + (power range error %) × (power range/apparent power indication value) + |tanφ × (influence when λ = 0)%|. φ is the phase angle between the voltage and current.
 Value of "influence % when λ = 0" will be changed by frequency according to above expressions.

Influence of line filter

Voltage/Current		
When cutoff frequency is 500 Hz	Under 45 Hz: Add 0.5% of reading 45 to 66 Hz: Add 0.2% of reading	
When cutoff frequency is 5.5 kHz	66 Hz or less: Add 0.2% of reading 66 to 500 Hz: Add 0.5% of reading	
When cutoff frequency is 50 kHz	500 Hz or less: Add 0.2% of reading 500 to 5 kHz: Add 1% of reading	
Power		
When cutoff frequency is 500 Hz	Under 45 Hz: Add 1% of reading 45 to 66 Hz: Add 0.3% of reading	
When cutoff frequency is 5.5 kHz	66 Hz or less: Add 0.3% of reading 66 to 500 Hz: Add 1% of reading	
When cutoff frequency is 50 kHz	500 Hz or less: Add 0.3% of reading 500 to 5 kHz: Add 1% of reading	

Lead/Lag Detection (d (LEAD)/G (LAG) of the phase angle and symbols for the reactive power Q_r calculation)

*The s symbol shows the lead/lag of each element, and "-" indicates leading.

Voltage/Current and Power

The phase lead and lag are detected correctly when the voltage and current signals are both sine waves, the lead/lag is 50% of the range rating (or 100% for crest factor 6), the frequency is between 20 Hz and 10 kHz, and the phase angle is ±(5° to 175°) or more.

Temperature coefficient

Voltage/Current and Power: 0.02% of reading/°C at 5 to 18°C or 28 to 40°C.

Effective input range

Voltage/Current and Power

Udc and ldc are 0 to ±130% of the measurement range
 Urms and lrms are 1 to 130%* of the measurement range (or 2% to 130% for crest factor 6)
 Umn and lmn are 10 to 130% of the measurement range
 Urms and lrms are 10 to 130%* of the measurement range
 Power is 0 to ±130%* for DC measurement, 1 to 130%* of the voltage and current range for AC measurement, and up to ±130%* of the power range.
 However, when the data update rate is 50 ms, 100 ms, 5 sec, 10 sec, or 20 sec, the synchronization source level falls below the input signal of frequency measurement.
 *110% for maximum range of direct voltage and current inputs. The accuracy at 110 to 130% of the measurement range is the reading error × 1.5.
 The accuracy over 110% to 150% of DC voltage input under 1000 V range is adding the reading error × 1.5. It is a reference value.

Max. display

Voltage/Current and Power

140%* of the voltage and current range rating.
 *160% when the voltage range is 1000 V.

Min. display

Voltage/Current and Power

Urms and lrms are up to 0.3% relative to the measurement range (or up to 0.6% for a crest factor of 6).
 Umn, Urms, lmn, and lrms are up to 2% (or 4% for a crest factor of 6).
 Below that, zero suppress. Current integration value q also depends on the current value.

Measurement lower limit frequency

Voltage/Current and Power

Data update rate	50 ms	100 ms	250 ms	500 ms	1 s	2 s	5 s	10 s	20 s
Measurement lower limit frequency	45 Hz	25 Hz	20 Hz	10 Hz	5 Hz	2 Hz	0.5 Hz	0.2 Hz	0.1 Hz

Accuracy of apparent power S

Voltage accuracy + current accuracy

Accuracy of reactive power Q

Accuracy of apparent power + (√(1.0004 - λ²) - √(1 - λ²)) × 100% of range

Accuracy of power factor λ

±[(λ - λ/1.0002) + |cosφ - cos(φ + sin⁻¹(influence of power factor of power when λ = 0%)/100|)] ± 1 digit when voltage and current is at rated input of the measurement range.
 φ is the phase difference of voltage and current.

Accuracy of phase difference φ

±[|φ - cos⁻¹(λ/1.0002)| + sin⁻¹(influence of power factor of power when λ = 0%)/100] deg ± 1 digit when voltage and current is at rated input of the measurement range

One-year accuracy

Voltage/Current and Power

Add the accuracy of reading error (Six-month) × 0.5 to the accuracy Six-month

Specifications

Functions	
Measurement method	Digital multiplication method
Crest factor	3 or 6 (when inputting rated values of the measurement range), and 300 relative to the minimum valid input. However, 1.6 or 3.2 at the maximum range (when inputting rated values of the measurement range), and 160 relative to the minimum valid input.
Measurement period	Interval for determining the measurement function and performing calculations. Period used to determine and compute the measurement function. <ul style="list-style-type: none"> The measurement period is set by the zero crossing of the reference signal (synchronization source) when the data update interval is 50 ms, 100 ms, 5 s, 10 s, or 20 s (excluding watt hour WP as well as ampere hour q during DC mode). Measured through exponential averaging on the sampled data within the data update interval when the data update interval is 250 ms, 500 ms, 1 s, or 2 s. For harmonic measurement, the measurement period is from the beginning of the data update interval to 9000 points at the harmonic sampling frequency.
Wiring	You can select one of the following five wiring settings. 1P2W (single phase, two-wire), 1P3W (single phase, 3 wire), 3P3W (3 phase, 3 wire), 3P4W (3 phase, 4 wire), 3P3W (3V3A) (3 phase, 3 wire, 3 volt/3 amp measurement). However, the number of available wiring settings varies depending on the number of installed input elements. Up to four, or only one, two, or three wiring settings may be available.
Compensation Functions	<ul style="list-style-type: none"> Efficiency Compensation Compensation of instrument loss during efficiency calculation Wiring Compensation Compensation of instrument loss due to wiring 2 Wattmeter Method Compensation (Delta Function) Compensation for 2 wattmeter method
Scaling	When inputting output from external current sensors, VT, or CT, set the current sensor conversion ratio, VT ratio, CT ratio, and power coefficient in the range from 0.0001 to 99999.9999.
Input filter	Line filter or frequency filter settings can be entered.
Averaging	The average calculations below are performed on the normal measurement parameters of voltage U, current I, power P, apparent power S, reactive power Q. Power factor λ and phase angle φ are determined by calculating the average of P and S. Select exponential or moving averaging. <ul style="list-style-type: none"> Exponential average Select an attenuation constant of 2, 4, 8, 16, 32, or 64. Moving average Select the number of averages from 8, 16, 32, 64, 128, or 256. The average calculations below are performed on the harmonic display items of voltage U, current I, power P, apparent power S, reactive power Q. Power factor λ is determined by calculating the average of P and Q. Only exponential averaging is performed. Select an attenuation constant of 2, 4, 8, 16, 32 or 64.
Data update rate	Select 50 ms, 100 ms, 250 ms, 500 ms, 1 s, 2 s, 5 s, 10 s, or 20 s.
Response time	At maximum, two times the data update rate (only during numerical display)
Hold	Holds the data display.
Single	Executes a single measurement during measurement hold.
Zero level compensation/Null	Compensates the zero level.
Integration	
Mode	Select a mode of Manual, Standard, Continuous (repeat), Real Time Control Standard, or Real Time Control Continuous (Repeat).
Timer	Integration can be stopped automatically using the integration timer setting. 0000 h 00 m 00 s to 10000 h 00 m 00 s
Count over	If the count over integration time reaches the maximum integration time (10000 hours), or if the integration value reaches max/min display integration value (±999999 M), the elapsed time and value is saved and the operation is stopped.
Accuracy	±[power accuracy (or current accuracy) + time accuracy]
Time accuracy	±0.02% of reading
Remote control	EXT START, EXT STOP, EXT RESET, EXT HOLD, EXT SINGLE and EXT PRINT (all input signal) /INTEG BUSY (output signal). Requires /DA option.
Display	
Numerical display function	
Display resolution	600000
Number of display items	Select 4, 8, 16, all, single list, or dual list.
Waveform display items	
No. of display rasters	501
Display format	Peak-peak compressed data
Time axis	Range from 0.5 ms to 2 s/div. However, it must be 1/10th of the data update rate.
Triggers	
Trigger Type	Edge type
Trigger Mode	Select Auto, Normal or OFF. Triggers are turned OFF automatically during integration.

WT3000E

Trigger Source	Select from the voltage or current applied to the input element and external clock.
Trigger Slope	Select (Rising), (Falling), or (Rising/Falling).
Trigger Level	When the trigger source is the voltage or current input to the input elements. Set in the range from the center of the screen to ±100% (top/bottom edge of the screen). Setting resolution: 0.1% When the trigger source is Ext Clk, TTL level.
Vertical axis Zoom	Voltage and current input to the waveform vertical axis zoom input element can be zoomed along the vertical axis. Set in the range of 0.1 to 100 times.
ON/OFF	ON/OFF can be set for each voltage and current input to the input element.
Format	You can select 1, 2, 3 or 4 splits for the waveform display.
Interpolation	Select dot or linear interpolation.
Graticule	Select grid or cross scale display.
Other display ON/OFF	Upper/lower limit (scale value), and waveform label ON/OFF.
Cursor measurements	When you place the cursor on the waveform, the value of that point is measured.
Zoom function	No time axis zoom function

*Since the sampling frequency is approximately 200 kHz, waveforms that can be accurately reproduced are those of about 10 kHz.

Vector Display/Bar Graph Display (Requires /G6 option)

Vector display	Vector display of the phase difference in the fundamental waves of voltage and current. (without Single Input Element model)
Bar graph display	Displays the size of each harmonic in a bar graph.

Trend display	Number of measurement channels Up to 16 parameters. Displays trends (transitions) in numerical data of the measurement functions in a sequential line graph.
----------------------	---

Simultaneous display	Two windows can be selected (from numerical display, waveform display, bar graph display, or trend display) and displayed in the upper and lower parts of the screen.
-----------------------------	---

Saving and Loading Data

Settings, waveform display data, numerical data, and screen image data can be saved to media.*
Saved settings can be loaded from a medium.
*PC card, USB memory (Requires /C5 option)

Store function

Internal memory size	Approx. 30 MB
Store interval (waveform OFF)	Maximum 50 msec to 99 hour 59 minutes 59 seconds.

Guideline for Storage Time (Waveform Display OFF, Integration Function OFF)

Number of measurement channels	Measured Items (Per CH)	Storage Interval	Storable Amnt. of Data
2 ch	3	50 ms	Approx. 10 hr 20 m
2 ch	10	1 sec	Approx. 86 hr
4 ch	10	50 ms	Approx. 2 hr 30 m
4 ch	20	1 sec	Approx. 24 hr

Note: Depending on the user-defined math, integration, and other settings, the actual measurement time may be shorter than stated above.
Store function can't use in combination with auto print function.

Delta Calculation Function

	Item	Specifications
Voltage (V)	difference	ΔU1: Differential voltage determined by computation u1 and u2
	3P3W -> 3V3A	ΔU1: Line voltage that are not measured but can be computed for a threephase, three-wire system
	DELTA -> STAR	ΔU1, ΔU2, ΔU3: Line voltage that can be computed for a three phase, three-wire (3V3A) system
	STAR -> DELTA	ΔU1, ΔU2, ΔU3: Neutral line voltage that can be computed for a three phase, four-wire system
Current (A)	difference	ΔI1: Differential current determined by computation
	3P3W -> 3V3A	Phase current that are not measured but can be computed
	DELTA -> STAR	Neutral line current
	STAR -> DELTA	Neutral line current

Cycle-by-cycle measurement

Measurement items	Freq (Synch source frequency), U, I, P, S, Q, λ, Speed, Torque and Pm
Synch source	Select an external source of U1, I1, U2, I2, U3, I3, U4, or I4. (the above parameters are measured continuously for each cycle of the one sync source signal)
Number of measurements	10 to 3000
Timeout time	0, 1 to 3600 seconds (set in units of seconds). (when it is set to 0, it is approx. 24 hours)
Synch source frequency range	1 Hz to 1000 Hz (for U and I) 0.1 Hz to 1000 Hz (for Ext Clk)

Accuracy

U, I, P	Add [(0.3 + 2 × f)% of reading + ((0.05 + 0.05 × f)% of range)] to the accuracy for normal measurement. For external current sensor input, Add (100 + 100 × f) μV to the accuracy.
Freq	Add [(0.3 + 2 × f)% of reading to the accuracy for normal measurement.

*f is kHz

Motor Evaluation Function (/MTR Optional)	
Measurement Function	Method of Determination, Equation
Rotating speed	When the input signal from the revolution sensor is DC voltage (analog signal) Input voltage from revolution sensor × scaling factor Scaling factor: Number of revolutions per 1 V input voltage When the input signal from the revolution sensor is number of pulses $\frac{\text{Number of input pulses from revolution sensor per minute}}{\text{Number of pulses per rotation}} \times \text{Scaling factor}$
Torque	When the type of input signal from the torque meter is DC voltage (analog signal) Input voltage from torque meter × scaling factor Scaling factor: Torque per 1 V input voltage When the type of input signal from the torque meter is pulses Enter torque values [N·m] equivalent to upper- and lower-limit frequencies to determine an inclination from these two frequencies, and then multiply the number of pulses.
SyncSp	$120 \times \text{freq. of the freq. meas. source} \div \text{motor's number of poles}$
Slip [%]	$\frac{\text{SyncSp} - \text{Speed}}{\text{SyncSp}} \times 100$
Motor output Pm	$\frac{2\pi \times \text{Speed} \times \text{Torque}}{60} \times \text{scaling factor}$

Revolution signal, torque signal

When revolution and torque signals are DC voltage (analog input)	
Connector type	Insulated BNC connector
Input range	1 V, 2 V, 5 V, 10 V, 20 V
Effective input range	0% to ±110% of measurement range
Input resistance	Approx. 1 MΩ
Continuous maximum allowed input	±22 V
Continuous maximum common mode voltage	±42 Vpeak or less
Accuracy	±(0.1% of reading + 0.1% of range)
Temperature coefficient	±0.03% of range/°C
When revolution and torque signals are pulse input	
Connector type	Insulated BNC connector
Frequency range	2 Hz to 200 kHz
Amplitude input range	±12 Vpeak
Effective amplitude	1 V (peak to peak) or more
Input waveform duty ratio	50%, square wave
Input resistance	Approx. 1 MΩ
Continuous maximum common mode voltage	±42 Vpeak or less
Accuracy	±(0.05% of reading + 1 mHz)

Added Frequency Measurement (/FQ Optional)

Device under measurement	If the frequency option (/FQ) is installed, the frequencies of the voltages and currents being input to all input elements can be measured.	
Measurement method	Reciprocal method	
Measurement range	Data Update Rate	Measuring Range
	50 ms	45 Hz ≤ f ≤ 1 MHz
	100 ms	25 Hz ≤ f ≤ 1 MHz
	250 ms	10 Hz ≤ f ≤ 500 kHz
	500 ms	5 Hz ≤ f ≤ 200 kHz
	1 s	2.5 Hz ≤ f ≤ 100 kHz
	2 s	1.5 Hz ≤ f ≤ 50 kHz
	5 s	0.5 Hz ≤ f ≤ 20 kHz
	10 s	0.25 Hz ≤ f ≤ 10 kHz
	20 s	0.15 Hz ≤ f ≤ 5 kHz

Accuracy ±0.05% of reading
 When the input signal levels are greater than or equal to 25 mV (external current sensor input), 1.5 mA (current direct input of 2 A input element) and 150 mA (current direct input of 30 A input element) respectively, and the signal is greater than or equal to 30% (0.1 Hz to 440 Hz, frequency filter ON), 10% (440 Hz to 500 kHz), or 30% (500 kHz to 1 MHz) of the measurement range. However, when the measuring frequency is smaller or equal to 2 times of above lower frequency, the input signal is greater than or equal to 50%.
 Add 0.05% of reading when external current input is smaller than or equal to 50 mV input signal level for each is double for crest factor 6.

D/A Output (/DA Optional)

D/A conversion resolution	16 bits
Output voltage	±5 V FS (max. approximately ±7.5 V) for each rated value
Update rate	Same as the data update rate on the main unit.
Number of outputs	20 channels (each channel can be set separately)
Accuracy	±(accuracy of a given measurement function + 0.1% of FS) FS = 5 V
D/A zoom	Setting maximum and minimum values.

Continuous maximum common mode voltage	±42 Vpeak or less
Minimum load	100 kΩ
Temperature coefficient	±0.05% of FS/°C
Remote control	EXT START, EXT STOP, EXT RESET, EXT HOLD, EXT SINGLE and EXT PRINT (all input signal) / INTEG BUSY (output signal) Requires /DA option

Frequency (Simplified Figure Below)

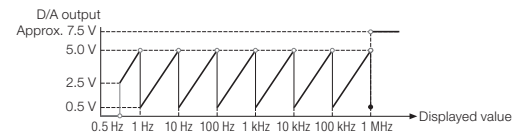

Integrated Value

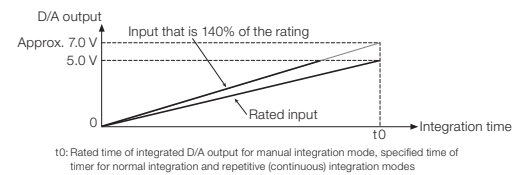

Other Items

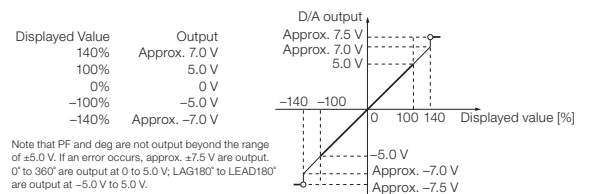

Built-in Printer (/B5 Optional)

Printing method	Thermal line-dot
Dot density	8 dots/mm
Paper width	112 mm
Effective recording width	104 mm
Recorded information	Screenshots, list of measured values, harmonic bar graph printouts, settings
Auto print function	Measured values are printed out automatically. However, auto print function can't use in combination with store function.

RGB Video Signal (VGA) Output Section (/V1 Optional)

Connector type	15-pin D-Sub (receptacle)
Output format	VGA compatible

Advanced Calculation (/G6 optional)

Wide Bandwidth Harmonic Measurement	Measured source All installed elements
Format	<ul style="list-style-type: none"> • PLL synchronization method When the PLL source is not set to Smp Clk • External sampling clock method When the PLL source is set to Smp Clk
Frequency range	<ul style="list-style-type: none"> • PLL synchronization method Fundamental frequency of the PLL source is in the range of 10 Hz to 2.6 kHz. • External sampling clock method Input a sampling clock signal having a frequency that is 3000 times the fundamental frequency between 0.1 Hz and 66 Hz of the waveform on which to perform harmonic measurement. The input level is TTL. The input waveform is a rectangular wave with a duty ratio of 50%.
PLL source	<ul style="list-style-type: none"> • Select the voltage or current of each input element (external current sensor range is greater than or equal to 500 mV) or the external clock (Ext Clk or Smp Clk). • Input level Greater than or equal to 50% of the measurement range rating when the crest factor is 3 Greater than or equal to 100% of the measurement range rating when the crest factor is 6 • Turn the frequency filter ON when the fundamental frequency is less than or equal to 440 Hz.
FFT data length	9000
FFT processing word length	32 bits
Window function	Rectangular
Anti-aliasing filter	Set using a line filter (OFF, 500 Hz, 5.5 kHz, or 50 kHz).

Sample rate (sampling frequency), window width, and upper limit of measured order

PLL source synchronization method

Fundamental Frequency of the PLL Source (Hz)	Sample Rate (S/s)	Window Width against the FFT Data Length (Frequency of the Fundamental Wave)	Upper Limit of the Measured Order
10 to 20	f × 3000	3	100
20 to 40	f × 1500	6	100
40 to 55	f × 900	10	100
55 to 75	f × 750	12	100
75 to 150	f × 450	20	62
150 to 440	f × 360	25	62
440 to 1100	f × 150	60	62
1100 to 2600	f × 60	150	20

External sampling clock method

Fundamental Frequency of the PLL Source (Hz)	Sample Rate (S/s)	Window Width against the FFT Data Length (Frequency of the Fundamental Wave)	Upper Limit of the Measured Order
0.1 to 66	f × 3000	3	100

Accuracy

When the line filter (500 Hz) is ON

Frequency	Voltage and Current	Power
0.1 Hz ≤ f < 10 Hz	0.7% of reading + 0.3% of range	1.4% of reading + 0.4% of range
10 Hz ≤ f < 30 Hz	0.7% of reading + 0.3% of range	1.4% of reading + 0.4% of range
30 Hz ≤ f < 66 Hz	0.7% of reading + 0.05% of range	1.4% of reading + 0.1% of range

When the line filter (5.5 kHz) is ON

Frequency	Voltage and Current	Power
0.1 Hz ≤ f < 10 Hz	0.25% of reading + 0.3% of range	0.5% of reading + 0.4% of range
10 Hz ≤ f < 30 Hz	0.25% of reading + 0.3% of range	0.5% of reading + 0.4% of range
30 Hz ≤ f ≤ 66 Hz	0.3% of reading + 0.05% of range	0.45% of reading + 0.1% of range
66 Hz < f ≤ 440 Hz	0.6% of reading + 0.05% of range	1.2% of reading + 0.1% of range
440 Hz < f ≤ 1 kHz	1% of reading + 0.05% of range	2% of reading + 0.1% of range
1 kHz < f ≤ 2.5 kHz	2.5% of reading + 0.05% of range	5% of reading + 0.15% of range
2.5 kHz < f ≤ 3.5 kHz	8% of reading + 0.05% of range	16% of reading + 0.15% of range

If the fundamental frequency is between 1 kHz and 2.6 kHz

- Add 0.5% of reading to the voltage and current accuracy for frequencies greater than 1 kHz.
- Add 1% of reading to the power accuracy for frequencies greater than 1 kHz.

When the line filter (50 kHz) is ON

Frequency	Voltage and Current	Power
0.1 Hz ≤ f < 10 Hz	0.25% of reading + 0.3% of range	0.45% of reading + 0.4% of range
10 Hz ≤ f < 30 Hz	0.25% of reading + 0.3% of range	0.45% of reading + 0.4% of range
30 Hz ≤ f ≤ 440 Hz	0.3% of reading + 0.05% of range	0.45% of reading + 0.1% of range
440 Hz < f ≤ 1 kHz	0.7% of reading + 0.05% of range	1.4% of reading + 0.1% of range
1 kHz < f ≤ 5 kHz	0.7% of reading + 0.05% of range	1.4% of reading + 0.15% of range
5 kHz < f ≤ 10 kHz	3.0% of reading + 0.05% of range	6% of reading + 0.15% of range

If the fundamental frequency is between 1 kHz and 2.6 kHz

- Add 0.5% of reading to the voltage and current accuracy for frequencies greater than 1 kHz.
- Add 1% of reading to the power accuracy for frequencies greater than 1 kHz.

When the line filter is OFF

Frequency	Voltage and Current	Power
0.1 Hz ≤ f < 10 Hz	0.15% of reading + 0.3% of range	0.25% of reading + 0.4% of range
10 Hz ≤ f < 30 Hz	0.15% of reading + 0.3% of range	0.25% of reading + 0.4% of range
30 Hz ≤ f ≤ 1 kHz	0.1% of reading + 0.05% of range	0.2% of reading + 0.1% of range
1 kHz < f ≤ 10 kHz	0.3% of reading + 0.05% of range	0.6% of reading + 0.15% of range
10 kHz < f ≤ 55 kHz	1% of reading + 0.2% of range	2% of reading + 0.4% of range

If the fundamental frequency is between 400 Hz and 1 kHz

- Add 1.5% of reading to the voltage and current accuracy for frequencies greater than 10 kHz.
- Add 3% of reading to the power accuracy for frequencies greater than 10 kHz.

If the fundamental frequency is between 1 kHz and 2.6 kHz

- Add 0.5% of reading to the voltage and current accuracy for frequencies greater than 1 kHz and less than or equal to 10 kHz.
- Add 7% of reading to the voltage and current accuracy for frequencies greater than 10 kHz.
- Add 1% of reading to the power accuracy for frequencies greater than 1 kHz and less than equal to 10 kHz.
- Add 14% of reading to the power accuracy for frequencies greater than 10 kHz.

However, all the items below apply to all tables.

- When the crest factor is set to 3
- When λ (power factor) = 1
- Power figures that exceed 440 Hz are reference values.
- For external current sensor range, add 0.2 mV to the current accuracy and add (0.2 mV/external current sensor range rating) × 100% of range to the power accuracy.
- For 30 A direct current input range, add 0.2 mA to the current accuracy and add (0.2 mA/direct current input range rating) × 100% of range to the power accuracy.
- For 2 A direct current input range, add 2 μA to the current accuracy and add (2 μA/direct current input range rating) × 100% of range to the power accuracy.

- For nth order component input, add {n/(m+1)}/50% of (the nth order reading) to the n+mth order and n-mth order of the voltage and current, and add {n/(m+1)}/25% of (the nth order reading) to the n+mth order and n-mth order of the power.
- Add (n/500)% of reading to the nth component of the voltage and current, and add (n/250)% of reading to the nth component of the power.
- Accuracy when the crest factor is 6: The same as when the range is doubled for crest factor 3.
- The accuracy guaranteed range by frequency and voltage/current is the same as the guaranteed range of normal measurement.

Frequency Measurement range	<ul style="list-style-type: none"> • PLL synchronization method: 2.5 Hz ≤ f ≤ 100 kHz • External sampling clock method: 0.15 Hz ≤ f ≤ 5 kHz
Display update (Depends on the PLL source)	<ul style="list-style-type: none"> • PLL synchronization method: 1 s or more • External sampling clock method: 20 s or more
PPL Timeout value (Depends on the PLL source)	<ul style="list-style-type: none"> • PLL synchronization method: 5 s or more • External sampling clock method: 40 s or more

IEC Harmonic Measurement (IEC Harmonic/Flicker measurement software 761922 is required.)

Measured source	Select an input element or an Σ wiring unit
Format	PLL synchronization method
Frequency range	Fundamental frequency of the PLL source is in the range of 45 Hz to 66 Hz.
PLL source	<ul style="list-style-type: none"> • Select the voltage or current of each input element (external current sensor range is greater than or equal to 500 mV) or the external clock (fundamental frequency). • Input level Greater than or equal to 50% of the measurement range rating when the crest factor is 3 Greater than or equal to 100% of the measurement range rating when the crest factor is 6 • Be sure to turn the frequency filter ON.
FFT data length	9000
FFT processing word length	32 bits
Window function	Rectangular
Anti-aliasing filter	Set using a line filter (cut off is 5.5 kHz).
Interharmonic measurement	Select OFF, Type1, or Type2.

Sample rate (sampling frequency), window width, and upper limit of measured order

Fundamental Frequency of the PLL Source (Hz)	Sample Rate (S/s)	Window Width against the FFT Data Length (Frequency of the Fundamental Wave)	Upper Limit of the Measured Order
45 to 55	f × 900	10	50
55 to 66	f × 750	12	50

Accuracy

When the line filter (5.5 kHz) is ON

Frequency	Voltage and Current	Power
45 Hz ≤ f ≤ 66 Hz	0.2% of reading + 0.04% of range	0.4% of reading + 0.05% of range
66 Hz < f ≤ 440 Hz	0.5% of reading + 0.05% of range	1.2% of reading + 0.1% of range
440 Hz < f ≤ 1 kHz	1% of reading + 0.05% of range	2% of reading + 0.1% of range
1 kHz < f ≤ 2.5 kHz	2.5% of reading + 0.05% of range	5% of reading + 0.15% of range
2.5 kHz < f ≤ 3.3 kHz	8% of reading + 0.05% of range	16% of reading + 0.15% of range

However, all the items below apply.

- When the crest factor is set to 3
- When λ (power factor) = 1
- Power figures that exceed 440 Hz are reference values.
- For external current sensor range, add 0.03 mV to the current accuracy and add (0.03 mV/external current sensor range rating) × 100% of range to the power accuracy.
- For 30 A direct current input range, add (0.1 mA/direct current input range rating) × 100% of range to the power accuracy.
- For 2 A direct current input range, add (1 μA/direct current input range rating) × 100% of range to the power accuracy.
- For direct current input in a range less than or equal to 200-mA on the 2-A input element, add 0.02% of reading + 0.01% of range to the current accuracy in the range of 45 Hz ≤ f ≤ 66 Hz and add 0.03% of reading + 0.01% of range to the power accuracy.
- For nth order component input, add {n/(m+1)}/50% of (the nth order reading) to the n+mth order and n-mth order of the voltage and current, and add {n/(m+1)}/25% of (the nth order reading) to the n+mth order and n-mth order of the power (only when applying a single frequency).
- Accuracy when the crest factor is 6: The same as when the range is doubled for crest factor 3.
- The accuracy guaranteed range by frequency and voltage/current is the same as the guaranteed range of normal measurement.

Frequency Measurement range	45 Hz ≤ f ≤ 1 MHz
Display update	Depends on the PLL source (Approx. 200 ms when the frequency of the PLL source is 45 Hz to 66 Hz.)

Waveform Computation Function

(Waveform calculation function (MATH) cannot be used with FFT calculation at the same time.)

Computed source	Voltage, current, and active power of each input element; torque (analog input) and speed (analog input) of motor input; and motor output
Equation	Two equations (MATH1 and MATH2)
Operator	+, −, ×, /, ABS (absolute value), SQR (square), SQRT (square root), LOG (natural logarithm), LOG10 (common logarithm), EXP (exponent), NEG (negation), AVG2, AVG4, AVG8, AVG16, AVG32, AVG64 (exponential average).

Sampling clock	Fixed to 200 kHz
Display update	Data update interval + computing time
FFT Function Specifications (Waveform calculation function (MATH) cannot be used with FFT calculation at the same time.)	
Computed source	Voltage, current, active power, and reactive power of each input element. Active power and reactive power of an Σ wiring unit. Torque and speed signals (analog input) of motor input (option).
Type	PS (power spectrum)
Number of computations	Two computations (FFT1 and FFT2)
Maximum frequency of analysis	100 kHz
Number of points	20000 points or 200000 points
Measurement period for the computation	100 ms or 1 s* *The measurement period is 1 s when the number of FFT points is 200 k (when the frequency resolution is 1 Hz). The measurement period is 100 ms when the number of FFT points is 20 k (when the frequency resolution is 10 Hz).
Frequency resolution	10 Hz or 1 Hz
Window function	Rectangular, Hanning, or Flattop
Anti-aliasing filter	Set using a line filter (OFF, 500 Hz, 5.5 kHz, or 50 kHz).
Sampling clock	Fixed to 200 kHz
Display update	Data update rate or (measurement period of the FFT + FFT computing time), whichever is longer

Harmonic Measurement in Normal Measurement (To measure and display harmonic data requires a data update rate of 500 ms or more)	
Measured source	All installed elements
Format	PLL synchronization method
Frequency range	Range in which the fundamental frequency of the PLL source is 10 Hz to 2600 Hz

PLL source

- Select the voltage or current of each input element (external current sensor range is greater than or equal to 500 mV) or the external clock (Ext Clk).
- Input level
Greater than or equal to 50% of the measurement range rating when the crest factor is 3
Greater than or equal to 100% of the measurement range rating when the crest factor is 6
- Turn the frequency filter ON when the fundamental frequency is less than or equal to 440 Hz.

FFT data length	9000
FFT processing word length	32 bits
Window function	Rectangular
Anti-aliasing filter	Set using a line filter (OFF, 5.5 kHz or 50 kHz).

Sample rate (sampling frequency), window width, and upper limit of measured order during PLL synchronization

On models with the advanced computation (/G6 option)

Fundamental the PLL Source (Hz)	Sample Rate (S/s)	Window Width against the FFT Data Length (Frequency of the Fundamental Wave)	Upper Limit of the Measured Order
10 to 20	f × 3000	3	100
20 to 40	f × 1500	6	100
40 to 55	f × 900	10	100
55 to 75	f × 750	12	100
75 to 150	f × 450	20	50
150 to 440	f × 360	25	15
440 to 1100	f × 150	60	7
1100 to 2600	f × 60	150	3

Accuracy

When the line filter (5.5 kHz) is ON

Frequency	Voltage and Current	Power
10 Hz ≤ f < 30 Hz	0.25% of reading + 0.3% of range	0.5% of reading + 0.4% of range
30 Hz ≤ f ≤ 66 Hz	0.2% of reading + 0.15% of range	0.4% of reading + 0.15% of range
66 Hz < f ≤ 440 Hz	0.5% of reading + 0.15% of range	1.2% of reading + 0.15% of range
440 Hz < f ≤ 1 kHz	1.2% of reading + 0.15% of range	2% of reading + 0.15% of range
1 kHz < f ≤ 2.5 kHz	2.5% of reading + 0.15% of range	6% of reading + 0.2% of range
2.5 kHz < f ≤ 3.5 kHz	8% of reading + 0.15% of range	16% of reading + 0.3% of range

If the fundamental frequency is between 1 kHz and 2.6 kHz, add 0.5% of reading to the voltage and current accuracy and 1% of reading to the power accuracy when the frequency exceeds 1 kHz.

When the line filter (50 kHz) is ON

Frequency	Voltage and Current	Power
10 Hz ≤ f < 30 Hz	0.25% of reading + 0.3% of range	0.45% of reading + 0.4% of range
30 Hz ≤ f ≤ 440 Hz	0.2% of reading + 0.15% of range	0.4% of reading + 0.15% of range
440 Hz < f ≤ 2.5 kHz	1% of reading + 0.15% of range	2% of reading + 0.2% of range
2.5 kHz < f ≤ 5 kHz	2% of reading + 0.15% of range	4% of reading + 0.2% of range
5 kHz < f ≤ 7.8 kHz	3.5% of reading + 0.15% of range	6.5% of reading + 0.2% of range

If the fundamental frequency is between 1 kHz and 2.6 kHz, add 0.5% of reading to the voltage and current accuracy and 1% of reading to the power accuracy when the frequency exceeds 1 kHz.

When the line filter is OFF

Frequency	Voltage and Current	Power
10 Hz ≤ f < 30 Hz	0.15% of reading + 0.3% of range	0.25% of reading + 0.4% of range
30 Hz ≤ f ≤ 440 Hz	0.1% of reading + 0.15% of range	0.2% of reading + 0.15% of range
440 Hz < f ≤ 2.5 kHz	0.6% of reading + 0.15% of range	1.2% of reading + 0.2% of range
2.5 kHz < f ≤ 5 kHz	1.6% of reading + 0.15% of range	3.2% of reading + 0.2% of range
5 kHz < f ≤ 7.8 kHz	2.5% of reading + 0.15% of range	5% of reading + 0.2% of range

If the fundamental frequency is between 1 kHz and 2.6 kHz, add 0.5% of reading to the voltage and current accuracy and 1% of reading to the power accuracy when the frequency exceeds 1 kHz.

However, all the items below apply to all tables.

- When averaging is ON, the averaging type is EXP, and the attenuation constant is greater than or equal to 8.
- When the crest factor is set to 3
- When λ (power factor) = 1
- Power exceeding 440 Hz are reference value.
- For external current sensor range, add 0.2 mV to the current accuracy and add (0.2 mV/ external current sensor range rating) × 100% of range to the power accuracy.
- For 30 A direct current input range, add 0.2 mA to the current accuracy and add (0.2 mA/ direct current input range rating) × 100% of range to the power accuracy.
- For 2 A direct current input range, add 2 μA to the current accuracy and add (2 μA/ direct current input range rating) × 100% of range to the power accuracy.
- For nth order component input, add (n/(n+1))/50% of (the nth order reading) to the n+mth order and n-mth order of the voltage and current, and add (n/(n+1))/25% of (the nth order reading) to the n+mth order and n-mth order of the power.
- Add (n/500)% of reading to the nth component of the voltage and current, and add (n/250)% of reading to the nth component of the power.
- Accuracy when the crest factor is 6: The same as when the range is doubled for crest factor 3.
- The accuracy guaranteed range by frequency and voltage/current is the same as the guaranteed range of normal measurement.

If the amplitude of the high frequency component is large, influence of approximately 1% may appear in certain orders. The influence depends on the size of the frequency component. Therefore, if the frequency component is small with respect to the range rating, this does not cause a problem.

Waveform Sampling Data Saving Function

Parameters	Voltage waveform, current waveform, analog input waveform of torque and speed waveform calculation, FFT performing data
Data type	CSV format, WWF format
Storage	PCMCIA, USB memory (Requires /C5 option)

Voltage Fluctuation/Flicker Measurement (/FL optional)

Flicker meter class	F2
---------------------	----

Normal Flicker Measurement Mode

Measurement Items (Measurement Functions)	
dc	Relative steady-state voltage change
dmax	Maximum relative voltage change
d(t) ⁺ , Tmax ⁺	The time during which the relative voltage change during a voltage fluctuation period exceeds the threshold level
Pst	Short-term flicker value
Plt	Long-term flicker value
One observation period	30 s to 15 min
Observation period count	1 to 99

Measurement of dmax Caused by Manual Switching Mode

Measurement (Measurement Functions)	dmax Maximum relative voltage change
One observation period	1 minute
Observation period count	24 Average of 22 measured dmax values excluding the maximum and minimum values among 24 values

Items Common to Measurement Modes

Target voltage/frequency	230 V/ 50 Hz, 120 V/60 Hz, 230 V/60 Hz*2 or 120 V/50 Hz*2
Measured item	All installed elements
Measured source input	Voltage (current measurement function not available)
Flicker scale	0.01 to 6400P.U. (20%) divided logarithmically into 1024 levels.
Display update	2 s (dc, dmax, d(t) ⁺ and Tmax ⁺) For every completion of a observation period (Pst)
Communication output	dc, dmax, d(t) ⁺ , Tmax ⁺ , Pst, Plt, instantaneous flicker sensation (IFS), and cumulative probability function (CPF)
Printer output	Screen image
External storage output	Screen image

Specifications

Accuracy	dc, dmax: $\pm 4\%$ (at dmax = 4%) Pst: $\pm 5\%$ (at Pst = 1) Conditions for the accuracy above <ul style="list-style-type: none"> Ambient temperature: $23 \pm 1^\circ\text{C}$ Line filter: OFF Input voltage range <ul style="list-style-type: none"> 220 V to 250 V at the 300 V measuring range 110 V to 130 V at the 150 V measuring range
----------	--

*1 When IEC61000-3-3 Ed 3.0 is selected, it is Tmax.
When IEC61000-3-3 Ed 2.0 is selected, it is dt).

*2 Correspond by IEC61000-4-15 Ed 2.0.

GP-IB Interface

Use one of the following by NATIONAL INSTRUMENTS:

- GPIB-USB-HS
 - PCI-GPIB and PCI-GPIB+
 - PCMCIA-GPIB and PCMCIA-GPIB+
- Use driver NI-488.2M version 1.60 or later excepting version 2.3.

Conforms electrically and mechanically	IEEE St'd 488-1978 (JIS C 1901-1992).
Functional specification	SH1, AH1, T6, L4, SR1, RL1, PP0, DC1, DT1, and C0.
Conforms to protocol	IEEE St'd 488.2-1992.
Encoding	ISO (ASCII)
Mode	Addressable mode
Address	0 to 30
Clear remote mode	Remote mode can be cleared using the LOCAL key (except during Local Lockout).

Ethernet Communications (/C7 Optional)

Number of communication ports	1
Connector type	RJ-45 connector
Electrical and mechanical specifications	Conforms to IEEE 802.3.
Transmission system	100BASE-TX/10BASE-T
Transmission rate	10 Mbps/100Mbps
Protocol	TCP/IP
Supported Services	FTP server, FTP client (network drive), LPR client (network printer), SMTP client (mail transmission), Web server, DHCP, DNS, Remote control

Serial (RS-232) Interface (/C2 Optional) *Select USB port (PC) or RS-232

Connector type	9-pin D-Sub (plug)
Electrical specifications	Conforms with EIA-574 (EIA-232 (RS-232) standard for 9-pin)
Connection type	Point-to-point
Communication mode	Full duplex
Synchronization method	Start-stop synchronization
Baud rate	Select from the following. 1200, 2400, 4800, 9600, 19200, 38400 bps

USB port (PC) (/C12 Optional) *Select USB port (PC) or RS-232

Connector	Type B connector (receptacle)
Electrical and Mechanical Specifications	Conforms to USB Rev.1.1
Speed	Max. 12 Mbps
Number of Ports	1
Supported service	Remote control
Supported Systems	Models with standard USB ports that run Windows Vista, Windows7 or Windows8/8.1 with USB port as a standard. (A separate device driver is required for connecting to a PC.)

USB port (Peripheral) (/C5 Optional)

Connector	Type A connector (receptacle)
Electrical and Mechanical Specifications	Conforms to USB Rev.1.1
Speed	Max. 12 Mbps
Number of Ports	2
Supported keyboards	104 keyboard (US) and 109 keyboard (Japanese) conforming to USB HID Class Ver.1.1 devices
Supported USB memory devices	USB (USB memory) flash memory
Power supply	5 V, 500 mA* (per port) *However, device whose maximum current consumption exceeds 100 mA cannot be connected simultaneously to the two ports.

WT3000E

External I/O	
I/O Section for Master/Slave Synchronization Signals	
Connector type	BNC connector: Both slave and master
External Clock Input Section	
Connector type	BNC connector
Input level	TTL
Inputting the synchronization source as the Ext Clk of normal measurement.	
Frequency range	Same as the measurement range for frequency measurement.
Input waveform	50% duty ratio square wave
Inputting the PLL source as the Ext Clk of harmonic measurement.	
Frequency range	10 Hz to 2.6 kHz
Input waveform	50% duty ratio square wave
Inputting the external sampling clock (Smp Clk) of wide bandwidth harmonic measurement.	
Frequency range	3000 times the frequency of 0.1 Hz to 66 Hz
Input waveform	50% duty ratio square wave
For Triggers	
Minimum pulse width	1 μs
Trigger delay time	Within (1 μs + 1 sample rate)
PC Card Interface	
TYPE II (Flash ATA card)	
General Specifications	
Warm-up time	Approx. thirty minutes.
Operating temperature	+5 to +40°C
Operating humidity	20 to 80% (when printer not used), 35 to 80% RH (when printer is used) (no condensation)
Operating altitude	2000 m or less
Installation location	Indoors
Storage environment	-25 to +60°C
Storage humidity	20 to 80% RH (no condensation)
Rated supply voltage	100 to 240 VAC
Allowed supply voltage fluctuation range	90 to 264 VAC
Rated supply frequency	50/60 Hz
Allowed supply frequency fluctuation	48 to 63 Hz
Maximum power consumption	150 VA (when using built-in printer)
Weight	Approx. 15 kg (including main unit, 4 input elements, and options)
Battery backup	Setup information and internal clock are backed up with the lithium battery
Exterior	

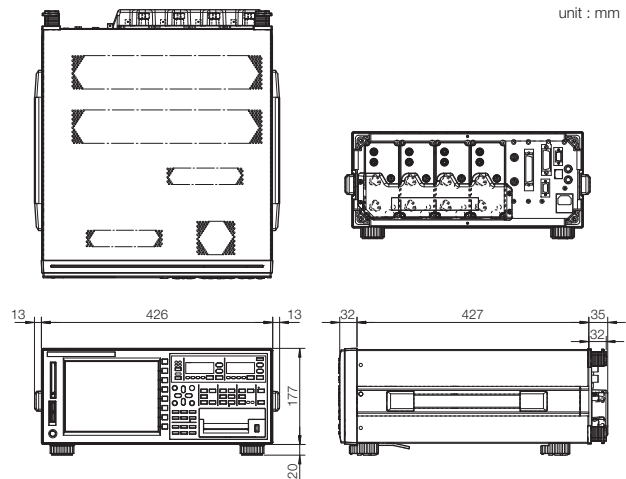

Accessories

Related products

19

Current Sensor Unit



751522, 751524

Current Sensor Unit DC to 100 kHz/1000 Apk

Current Output

- Wide dynamic range: -1000 A to 0 A to + 1000 A (DC)/1000 A peak (AC)
- Wide measurement frequency range: DC to 100 kHz (-3 dB)
- High-precision fundamental accuracy: $\pm(0.05\%$ of rdg + 40 μ A)
- Superior noise withstanding ability and CMRR characteristic due to optimized casing design

*751522/751524 do not conform to CE Marking
For detailed information, see Power Meter Accessory Catalog Bulletin CT1000-00E.)

Current Transducer



CT60/CT200/CT1000

Current Sensors

Current Output

- DC to 800 kHz/60 Apk, DC to 500 kHz/200 Apk, DC to 300 kHz/1000 Apk
- Wide dynamic range: 0 to 1000 A (DC) /1000 A peak (AC)
- Wide measurement frequency range: DC and up to 800 kHz
- High-precision fundamental accuracy: $\pm(0.05\%$ of reading + 30 μ A)
- 15 V DC power supply, connector, and load resistor required. For detailed information, see Current Sensors & Accessories Catalog Bulletin CT1000-00E.

Clamp on Probe



751552

Current Clamp on Probe AC 1000 Arms (1400 Apeak)

Current Output

- Measurement frequency range: 30 Hz to 5 kHz
- Basic accuracy: 0.3% of reading
- Maximum allowed input: AC 1000 Arms, max 1400 Apk (AC)
- Current output type: 1 mA/A

A separately sold fork terminal adapter set (758921), measurement leads (758917), etc. are required for connection to WT3000E. For detailed information, see Power Meter Accessory Catalog Bulletin CT1000-00E.
*751522 and 751524 do not conform to CE Marking.

Adapters and Cables



758917

Measurement leads

Two leads in a set. Use 758917 in combination with 758922 or 758929. Total length: 75 cm Rating: 1000 V, 32 A



758922

Small alligator adapters

For connection to measurement leads (758917). Two in a set. Rating: 300 V



758929

Large alligator adapters

For connection to measurement leads (758917). Two in a set. Rating: 1000 V



758923^{*1}

Safety terminal adapter set

(spring-hold type) Two adapters in a set.



758931^{*1}

Safety terminal adapter set

Screw-fastened adapters. Two adapters in a set. 1.5 mm Allen wrench included for tightening.



758921

Fork terminal adapter

Two adapters (red and black) to a set. Used when attaching banana plug to binding post.



701959

Safety mini-clip set (hook Type)

2 pieces (red and black) in one set. Rating 1000 V



758924

Conversion adapter

For conversion between male BNC and female banana plug



366924/25^{*2}

BNC cable

(BNC-BNC 1 m/2 m) For connection to simultaneously measurement with 2 units, or for input external trigger signal.



B9284LK^{*3}

External Sensor Cable

For connection the external input of the WT3000E to current sensor. Length: 50 cm

¹ Due to the nature of this product, it is possible to touch its metal parts. Therefore, there is a risk of electric shock, so the product must be used with caution.

^{*1} Maximum diameters of cables that can be connected to the adapters 758923 core diameter: 2.5 mm or less; sheath diameter: 4.8 mm or less 758931 core diameter: 1.8 mm or less; sheath diameter: 3.9 mm or less

^{*2} Use with a low-voltage circuit (42 V or less)

^{*3} The coax cable is simply cut on the current sensor side. Preparation by the user is required.

Typical Voltage/Current Connections

Measurement using current sensor

Connection example

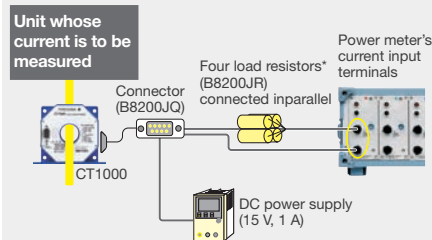

Measurement using clamp-on probe

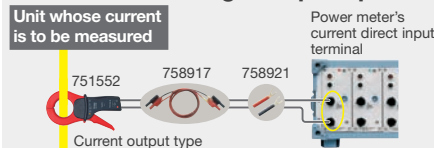

Current measurement using direct input terminal

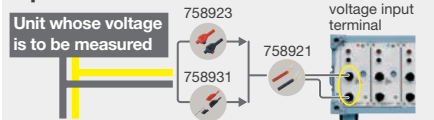

Measurement using voltage input terminal

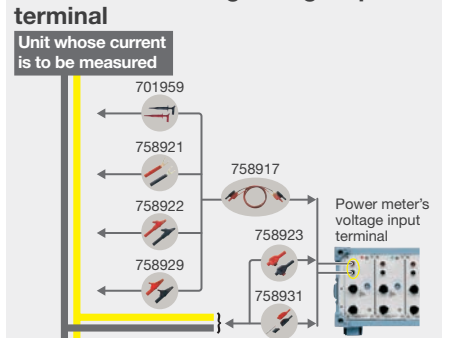

*A burden resistor is required for the CT1000, CT200 and CT60.

Model and Suffix code

Model	Suffix Code	Description
WT3001E		Precision Power Analyzer One Input Element Model
	-2A0 -30A1	30 A × 1 Input Element
	-2A1 -30A0	2 A × 1 Input Element
WT3002E		Precision Power Analyzer Two Input Elements Model
	-2A0 -30A2	30 A × 2 Input Elements
	-2A1 -30A1	2 A × 1 Input Element 30 A × 1 Input Element
	-2A2 -30A0	2 A × 2 Input Elements
WT3003E		Precision Power Analyzer Three Input Elements Model
	-2A0 -30A3	30 A × 3 Input Elements
	-2A1 -30A2	2 A × 1 Input Element 30 A × 2 Input Elements
	-2A2 -30A1	2 A × 2 Input Elements 30 A × 1 Input Element
	-2A3 -30A0	2 A × 3 Input Elements
WT3004E		Precision Power Analyzer Four Input Elements Model
	-2A0 -30A4	30 A × 4 Input Elements
	-2A1 -30A3	2 A × 1 Input Element 30 A × 3 Input Elements
	-2A2 -30A2	2 A × 2 Input Elements 30 A × 2 Input Elements
	-2A3 -30A1	2 A × 3 Input Elements 30 A × 1 Input Element
Power cord	-D	UL/CSA standard, PSE compliant
	-F	VDE standard
Option	-H	GB standard
	-N	NBR standard
	-Q	BS standard
	-R	AS standard
	/G6	Advanced Calculation
	/B5	Built-in Printer
	/FQ	Add-On Frequency Measurement
/DA	20 ch DA Output	
/V1	VGA Output	
/C12	USB Port (PC)	
/C2	Serial (RS-232) Interface	} select one
/C7	Ethernet Interface	
/C5	USB Port (Peripheral)	
/FL	Voltage Fluctuation/Flicker	
/MTR	Motor Evaluation Function	

Standard accessories

Power cord, Spare power fuse, Rubber feet, current input protective cover, User's manual, expanded user's manual, communication interface user's manual, printer roll paper(provided only with /B5), connector (provided only with /DA) Safety terminal adapter 758931(provided two adapters in a set times input element number)



Safety terminal adapter 758931

*Cable B9284LK (light blue) for external current sensor input is sold separately. Safety terminal adapter 758931 is included with the WT3000E. Other cables and adapters must be purchased by the user.

■ Any company's names and product names mentioned in this document are trade names, trademarks or registered trademarks of their respective companies.

NOTICE

- Before operating the product, read the user's manual thoroughly for proper and safe operation.

Yokogawa's Approach to Preserving the Global Environment

- Yokogawa's electrical products are developed and produced in facilities that have received ISO14001 approval.
- In order to protect the global environment, Yokogawa's electrical products are designed in accordance with Yokogawa's Environmentally Friendly Product Design Guidelines and Product Design Assessment Criteria.

Accessory (sold separately)

Model/parts number	Product	Description	Order Q'ty
758917	Test lead set	A set of 0.8 m long, red and black test leads	1
758922	△ Small alligator-clip	Rated at 300 V and used in a pair	1
758929	△ Large alligator-clip	Rated at 1000 V and used in a pair	1
758923	Safety terminal adapter	(spring-hold type) Two adapters to a set.	1
758931	Safety terminal adapter	(screw-fastened type) Two adapters to a set. 1.5 mm hex Wrench is attached	1
758921	△ Fork terminal adapter	Banana-fork adapter. Two adapters to a set	1
701959	Safety mini-clip	Hook type. Two in a set	1
758924	△ Conversion adapter	BNC-banana-jack (female) adapter	1
366924	△* BNC-BNC cable	1 m	1
366925	△* BNC-BNC cable	2 m	1
B9284LK	△ External sensor cable	Current sensor input connector. Length 0.5 m	1
B9316FX	△ Printer roll pager	Thermal paper, 10 meters (1 roll)	10

△ Due to the nature of this product, it is possible to touch its metal parts. Therefore, there is a risk of electric shock, so the product must be used with caution.

*Use these products with low-voltage circuits (42V or less).

AC/DC Current sensor /Clamp on Probe

Model	Product Name	Description
CT1000	AC/DC Current sensor	DC to 300 kHz, (0.05% of reading +30 uA), 1000 Apk
CT200	AC/DC Current sensor	DC to 500 kHz, (0.05% of reading +30 uA), 200 Apk
CT60	AC/DC Current sensor	DC to 800 kHz, (0.05% of reading +30 uA), 60 Apk
751552	Clamp-on probe	30 Hz to 5 kHz, 1400 Apeak (1000 Arms)

*For detailed information, see Power Meter Accessory Catalog Bulletin CT1000-00E

Application Software

Model	Product	Description	Order Q'ty
760122	WTViewer Software	Data acquisition software	1
761922	Harmonic/Voltage fluctuation/Flicker Measurement Software	Standard-compliant measurement	1

Rack Mount

Model	Product	Description
751535-E4	Rack mounting kit	For EIA
751535-J4	Rack mounting kit	For JIS

Current Sensor Unit

Model	Suffix Code	Description	Specifications
751522		For Single-Phase	Measurement range: DC to 100 kHz Basic accuracy: ±(0.05% of rdg + 40 uA)
751524	-10	For Three-Phase U and V	
	-20	For Three-Phase U and W	
	-30	For Three-Phase U, V, and W	
Input Terminal	-TS	Short Terminal	
	-TM	Middle Terminal	
	-TL	Long Terminal	
Power cord	-D	UL/CSA Standard, PSE Compliant	
	-F	VDE Standard	
	-R	AS Standard	
	-Q	BS Standard	
	-H	GB Standard	
	-N	NBR Standard	
Option	/CV	Terminal Cover Correspond to Input Terminal "-TS" only	

*751524-10 is available for the WT3000E/WT1800/WT500, and 751524-20 is available for the WT330. 751522/751524 do not conform to CE Marking.

This is a Class A instrument based on Emission standards EN61326-1 and EN55011, and is designed for an industrial environment. Operation of this equipment in a residential area may cause radio interference, in which case users will be responsible for any interference which they cause.

YOKOGAWA

YOKOGAWA METERS & INSTRUMENTS CORPORATION

Global Sales Dept. /Phone: +81-422-52-6237 Facsimile: +81-422-52-6462
E-mail: tm@cs.jp.yokogawa.com

YOKOGAWA CORPORATION OF AMERICA
YOKOGAWA EUROPE B.V.
YOKOGAWA SHANGHAI TRADING CO., LTD.
YOKOGAWA ELECTRIC KOREA CO., LTD.
YOKOGAWA ENGINEERING ASIA PTE. LTD.
YOKOGAWA INDIA LTD.
YOKOGAWA ELECTRIC CIS LTD.
YOKOGAWA AMERICA DO SUL LTDA.
YOKOGAWA AUSTRALIA PTY. LTD.
YOKOGAWA MIDDLE EAST & AFRICA B.S.C(C)

Phone: +1-770-253-7000
Phone: +31-88-4641000
Phone: +86-21-6239-6363
Phone: +82-2-2628-3810
Phone: +65-6241-9933
Phone: +91-80-4158-6000
Phone: +7-495-737-7868
Phone: +55-11-5681-2400
Phone: +61-2-8870-1100
Phone: +973-17-358100

Facsimile: +1-770-254-0928
Facsimile: +31-88-4641111
Facsimile: +86-21-6880-4987
Facsimile: +82-2-2628-3899
Facsimile: +65-6241-2606
Facsimile: +91-80-2852-8656
Facsimile: +7-495-737-7869
Facsimile: +55-11-5681-4434
Facsimile: +61-2-8870-1111
Facsimile: +973-17-336100

YMI-KS-HMI-SE01

Subject to Change without notice.
Copyright © 2004, Yokogawa Electric Corporation
Copyright © 2011, Yokogawa Meters & Instruments Corporation

[Ed: 01/b]
Printed in Japan, 506(KP)

<http://tmi.yokogawa.com/>